



(AFAC-2020-290-018-E; 9602/22)
Agencia Federal de Aviación Civil

Dirección Ejecutiva de Aviación
Dirección de Aviación

4.1.4. OPS.-4948/ 2022.

Ciudad de México, a 10 de octubre de 2022
Asunto: Aut. Manual QRH EMB -145

Link Conexión Aérea, S.A. de C.V.
Blvd. Bernardo Quintana CS 9800,
Piso 7-B706, Centro Sur
C.P. 76090, Querétaro, Qro.

Ing. Gustavo Villafuerte Arredondo
Representante Legal

En atención a su escrito con referencia TAR-089/22 de fecha 26 de julio del año en curso, y de acuerdo a lo establecido en el Reglamento de la Ley de Aviación Civil y las Normas Oficiales Mexicanas en vigor, así como en lo establecido en los transitorios Cuarto y Quinto del Decreto por el que se crea el órgano administrativo desconcentrado de la Secretaría de Infraestructura, Comunicaciones y Transportes, denominado Agencia Federal de Aviación Civil se devuelven debidamente aprobadas las siguientes enmiendas aplicables a las aeronaves Embraer, modelo EMB-145, no teniendo inconveniente en su uso operacional:

Manual / Número de Parte	Revisión	Fecha	Aplica para las series
Quick Reference Handbook (QRH/1115/04) (Motores AE3007A1)	19	20-julio-2022	145481
Quick Reference Handbook (QRH/1115/06) (Motores AE3007A1P)	19	20-julio-2022	145063, 145067, 145080, 145078, 145071, 145138 y 145241

Nota: La presente autorización de la revisión anterior, queda supeditada a los comentarios realizados por la Dirección de Control una vez que esta información haya sido analizada por el personal de operaciones vuelo.

Dichas enmiendas deberán ser insertadas en el manual de vuelo con número de autorización **AUT. VLO.: 219/2013, de fecha 21 de octubre de 2013.**

Una copia en electrónico (CD) del manual queda en poder del archivo de esta Dirección, debiendo entregar la copia anexa al presente a la Comandancia de su base de operaciones, para mantener actualizado el Manual correspondiente en poder de dicha Comandancia de Aeropuerto.

Atentamente.

Ing. Pablo Carranza Plata
Director Ejecutivo de Aviación



C.c. Director General de la Agencia Federal de Aviación Civil.- Pte.
Director Ejecutivo de Seguridad Aérea.- Pte.
Comandancia Regional III Monterrey - Apto. Inter. De la C.D., de Guadalajara – Terminal-II., C.P. 45659, Gdl., Jal.- Pte.
Comandante del Apto. "Intercontinental de Querétaro" – Km. 22.5, Municipio Colon, c.p. 76270, Querétaro, Qro.- Pte.

JACC7ALA*GAMA*AEB7
\\10.33.57.201\Of\raiz\01\NAC\LINK CONEXIÓN AÉREA S.A. DE C.V\2022\9602-22 OF APROB REV 19 QRH.docx

Boulevard Adolfo López Mateos 1990, Colonia Los Alpes, C. P. 01010, Alcaldía Álvaro Obregón, CDMX.
T: (55) 5723 9300 www.gob.mx/afac



EMB145

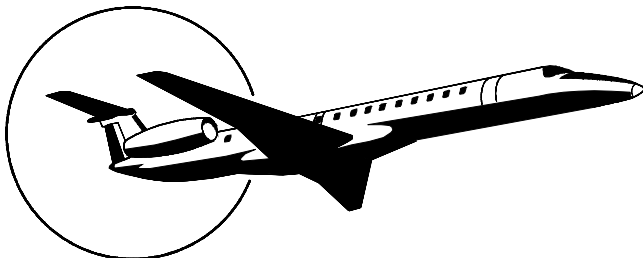

UNITED STATES QUICK REFERENCE HANDBOOK

THIS PUBLICATION CANCELS AND SUPERSEDES THE
QRH-145/1115 DATED APRIL 16, 2001; REVISION 8
DATED APRIL 04, 2005.

QRH-145/1115-06
SEPTEMBER 29, 2006
REVISION 19 – JULY 20, 2022

In connection with the use of this document, Embraer does not provide any express or implied warranties and expressly disclaims any warranty of merchantability or fitness for a particular purpose. This document contains trade secrets, confidential, proprietary information of Embraer and technical data subject to U.S. Export Administration Regulation ("EAR") and other countries export control laws and regulations. Diversion contrary to the EAR and other laws and regulations is strictly forbidden.

The above restrictions may apply to data on all pages of this document.

Copyright © 2022 by Embraer S.A. All rights reserved.

LIST OF EFFECTIVE PAGES

THE PORTION OF THE TEXT AFFECTED BY THE CHANGE IS INDICATED BY A VERTICAL LINE IN THE OUTER MARGIN OF THE PAGE.

ORIGINAL.....	0.....	SEP 29, 2006
REVISION	1.....	JUL 20, 2007
REVISION	2.....	NOV 30, 2007
REVISION	3.....	JUN 30, 2008
REVISION	4.....	DEC 19, 2008
REVISION	5.....	OCT 30, 2009
REVISION	6.....	JAN 29, 2010
REVISION	7.....	AUG 15, 2011
REVISION	8.....	JAN 10, 2012
REVISION	9.....	OCT 22, 2012
REVISION	10.....	OCT 29, 2012
REVISION	11.....	NOV 14, 2013
REVISION	12.....	MAY 20, 2014
REVISION	13.....	MAR 06, 2015
REVISION	14.....	APR 05, 2017
REVISION	15.....	MAR 26, 2018
REVISION	16.....	APR 26, 2019
REVISION	17.....	AUG 14, 2020
REVISION	18.....	APR 23, 2021
REVISION	19.....	JUL 20, 2022

TOTAL NUMBER OF PAGES IN THIS PUBLICATION IS 244 CONSISTING OF THE FOLLOWING:

PAGE N°	CHANGE N°	PAGE N°	CHANGE N°
* Title	19	NAP-1	15
		NAP-2	15
* A	19	NAP-2A	14
* B	19	NAP-2B	14
* C	19	NAP-3	14
		NAP-4	17
I	0	NAP-5	17
		NAP-6	17
NP INTRO-1	14	NAP-7	17
NP INTRO-2	14	NAP-8	14
		NAP-8A	14
NP-1	14	NAP-8B	14
NP-2	14	NAP-9	14
NP-3	14	NAP-10	14
NP-4	14	NAP-11	16
NP-5	16	NAP-12	14
NP-6	14	NAP-13	14
		NAP-14	15
EAP INTRO-1	16	NAP-15	17
EAP INTRO-2	16	NAP-16	14
EAP INTRO-3	16	NAP-17	14
EAP INTRO-4	16	NAP-18	14
		NAP-19	16
S-1	16	NAP-20	14
S-2	16	NAP-21	14
S-3	16	NAP-22	14
S-4	16	NAP-23	14
S-5	16	NAP-24	14
S-6	16	NAP-25	17
S-7	16	NAP-26	14
S-8	16	NAP-27	14
S-9	17	NAP-28	16
S-10	16	NAP-29	16
S-11	17	NAP-30	15
S-12	16	NAP-31	17
S-13	17	NAP-32	17
S-14	16	NAP-33	14
		NAP-34	14

* Asterisk indicates pages changed, added, or deleted by the current revision.

QRH-145/1115
CODE 06

LIST OF EFFECTIVE PAGES

THE PORTION OF THE TEXT AFFECTED BY THE CHANGE IS INDICATED BY A VERTICAL LINE IN THE OUTER MARGIN OF THE PAGE.

PAGE N°	CHANGE N°	PAGE N°	CHANGE N°
NAP-35	14	EAP5-5	16
NAP-36	15	EAP5-6	17
NAP-37	14	EAP5-7	17
NAP-38	14	EAP5-8	16
		EAP5-9	17
EAP0-1	15	EAP5-10	17
* EAP0-2	19	EAP5-11	16
EAP0-3	16	EAP5-12	16
EAP0-4	14	EAP5-13	17
EAP0-5	14	EAP5-14	17
EAP0-6	14		
EAP0-7	16	EAP6-1	14
EAP0-8	14	EAP6-2	14
		EAP6-3	14
EAP1-1	15	EAP6-4	14
EAP1-2	15	EAP6-5	14
EAP1-3	15	EAP6-6	14
EAP1-4	15	EAP6-6A	14
EAP1-5	15	EAP6-6B	14
EAP1-6	15	EAP6-7	14
EAP1-7	17	EAP6-8	14
EAP1-8	15	EAP6-9	14
EAP1-9	15	EAP6-10	14
EAP1-10	17	EAP6-11	14
EAP1-11	15	EAP6-12	14
EAP1-12	15		
EAP1-13	16	EAP7-1	16
EAP1-14	16	EAP7-2	15
		EAP7-3	15
EAP2-1	17	EAP7-4	15
EAP2-2	17	EAP7-5	15
EAP2-3	17	EAP7-6	15
EAP2-4	17		
EAP2-5	15	EAP8-1	14
EAP2-6	15	EAP8-2	14
EAP2-7	15	EAP8-3	14
EAP2-8	15	EAP8-4	14
EAP2-9	15	EAP8-5	14
EAP2-10	15	EAP8-6	14
EAP2-11	15	EAP8-7	14
EAP2-12	17	EAP8-8	17
EAP2-13	17	EAP8-9	14
EAP2-14	17	EAP8-10	16
EAP2-15	17	EAP8-11	16
EAP2-16	15	EAP8-12	14
EAP3-1	0	EAP9-1	5
EAP3-2	0	EAP9-2	5
EAP3-3	17	EAP9-3	13
EAP3-4	0	EAP9-4	17
EAP3-5	13	EAP9-5	1
EAP3-6	0	EAP9-6	5
		EAP9-7	5
EAP4-1	0	EAP9-8	0
EAP4-2	0	EAP9-9	0
EAP4-3	11	EAP9-10	0
EAP4-4	0		
EAP4-5	0	EAP10-1	14
EAP4-6	0	EAP10-2	14
		EAP10-3	14
EAP5-1	16	EAP10-4	14
EAP5-2	16	EAP10-5	14
EAP5-3	16	EAP10-6	14
EAP5-4	16	EAP10-7	14

* Asterisk indicates pages changed, added, or deleted by the current revision.

QRH-145/1115
CODE 06

LIST OF EFFECTIVE PAGES

THE PORTION OF THE TEXT AFFECTED BY THE CHANGE IS INDICATED BY A VERTICAL LINE IN THE OUTER MARGIN OF THE PAGE.

PAGE N°	CHANGE N°	PAGE N°	CHANGE N°
EAP10-8	14	
EAP11-1	0	
EAP11-2	0	
EAP11-3	0	
EAP11-4	0	
EAP11-5	1	
EAP11-6	0	
EAP11-7	11	
EAP11-8	11	
EAP12-1	14	
EAP12-2	14	
EAP12-3	14	
EAP12-4	17	
EAP12-5	14	
EAP12-6	14	
EAP12-7	14	
EAP12-8	14	
EAP13-1	1	
EAP13-2	1	
EAP13-3	1	
EAP13-4	0	
EAP14-1	0	
EAP14-2	0	
EAP14-3	11	
EAP14-4	11	
EAP14-5	11	
EAP14-6	0	
PD-1	17	
PD-2	17	
PD-3	17	
PD-4	17	
PD-5	17	
PD-6	17	
PD-7	17	
PD-8	17	
PD-9	17	
PD-10	17	
PD-11	17	
PD-12	17	
PD-13	17	
PD-14	17	
PD-15	17	
PD-16	18	
PD-17	18	
PD-18	18	
PD-19	18	
PD-20	18	
PD-21	18	
PD-22	18	
PD-23	18	
PD-24	18	
PD-25	18	
PD-26	18	
APP-1	0	
APP-2	17	

* Asterisk indicates pages changed, added, or deleted by the current revision.

QRH-145/1115
CODE 06

APPLICABILITY

This handbook is applicable to the EMB-135, ERJ-140 and the EMB-145 models.

The procedures contained in this handbook have been developed by the manufacturer for use during the operation of the EMB-135, ERJ-140 and EMB-145 models. These procedures are provided as guidance and should not be construed as prohibiting the development of equivalent procedures.

The use of the on board checklist is based on the assumption that both pilots have been properly trained on the type of airplane and, therefore, have a thorough knowledge of the airplane's systems and procedures.

It further assumes that they know the consequences of not performing the right actions at the right time.

In case of conflicting information between this handbook and the AFM-145/1153 or AFM-140/1330, the AFM must prevail.

NORMAL PROCEDURES

INTRODUCTION

The normal checklist is just a memory aid to assist the pilots so they do not forget actions which, if not carried out, can result in some type of risk to the airplane, to the operational environment, to any of its systems, to its occupants or to the passengers comfort. Specific regulations also ask for items to be included in the checklist.

The normal checklist assumes that the pilots previously accomplished all normal procedures.

The normal checklist is named and divided according to each specific phase of flight.

When a disagreement between the response and the checklist answer is found, the checklist should be interrupted until the item is resolved.

Upon completion of the checklist the pilot reading it should state: “_____ Checklist Complete”.

- * Items marked with an asterisk are to be performed at least once a day, by flight crew or maintenance personnel, at operator’s discretion.
- ◆ Items marked with a diamond are to be on through flights.

NORMAL PROCEDURES

INTENTIONALLY BLANK

User: aherrera - Printed By myTechCare - Jul 25/22 - 13:50:24

NORMAL PROCEDURES

INTERNAL SAFETY INSPECTION

CHALLENGE	ACTION
Maintenance Status	CKD
Cockpit Emergency Equip.....	CKD
Reinforced Cockpit Door	
Vent Louver (if applicable).....	OPN
Circuit Breakers	CKD
ELECTRIC Panel.....	SET
Emergency Lights	OFF
Fire Extinguishing Handle 1	PUSHED IN
FUEL Panel	SET
APU	SET
Ignitions.....	AUTO
START/STOP Selectors.....	STOP
Fire Extinguishing Handle 2	PUSHED IN
Ailerons & Rudders Shutoff	PUSHED IN
HYDRAULIC Panel.....	SET
Windshield Heating.....	PUSHED OUT
Sensors.....	PUSHED IN
Ice Detection Override	AUTO
AIR COND/PNEUM Panel	SET
Windshield Wipers (if installed).....	OFF
Lights	OFF
ELT	ARMED
Weather Radar.....	OFF
Landing Gear Lever	DOWN
Crew Oxygen	ON
PASSENGER OXYGEN Panel	SET
Gust Lock	LOCKED
Speed Brake	CLSD
Emergency/Parking Brake.....	AS RQRD
FLAPS Selector Lever	VERIFY POS
Alternate Gear Extension	
Compartment	CKD

NORMAL PROCEDURES

POWER UP

CHALLENGE	ACTION/RESPONSE
Batteries 1 & 2.....	AUTO
Avionics Master 1 or 2.....	PUSHED IN
* Batteries Voltage.....	CKD
* Backup Battery (EMB XR only)	CKD
GPU Voltage (if available).....	CKD
Avionics Master 1 & 2.....	PUSHED OUT
GPU (if available)	PUSHED IN
Fuel Pump Power Tank 2.....	AS RQRD
Navigation Light.....	ON
* FIRE EXTINGUISHER Panel.....	CKD
APU	AS RQRD
Avionics Master 1 & 2.....	PUSHED IN
.....With APU Power.....	
GPU (if available)	PUSHED OUT
.....3 minutes After APU Start.....	
APU Bleed.....	PUSHED IN
Air Conditioning.....	AS RQRD

BEFORE START

CHALLENGE	RESPONSE
Manuals & Documents.....	ON BOARD
CVR	CKD
ELECTRICAL Panel.....	SET
Emergency Lights.....	ARM
Push Button Lights	
Test (if installed).....	CKD
◆ FUEL Panel.....	SET
* Fire Detection.....	CKD
FIRE EXTINGUISHER Panel.....	CKD
POWERPLANT Panel	SET
* Elec Pump Sys 1 & 2.....	CKD
Elec Pump Sys 1 & 2.....	OFF
◆ PAX SIGNS Panel.....	SET
ICE PROTECTION Panel	SET
AIR COND/PNEUM Panel.....	SET
Oxy Masks & Regulators	CKD
Weather Radar	TST/STBY
Pitch Trim Cutout Buttons	CKD
DISPLAY CONTROL Panel	SET
◆ Flight Number & Clocks	SET

CONTINUES ON NEXT PAGE

NORMAL PROCEDURES

CONTINUED FROM PREVIOUS PAGE

CHALLENGE	RESPONSE
AHRS (if applicable).....	SET
IRS (if applicable).....	NAV
Autopilot	CKD
Gust Lock	LOCKED
REVERSIONARY Panel	SET
◆ Flight Instruments.....	SET/X-CKD
◆ RMU.....	SET
Thrust Levers	IDLE
◆ Stall Protection System	CKD
TRIM Panel.....	CKD
◆ PRESSURIZATION Panel	SET
◆ FMS	SET

◆ Fuel QTY	CKD
◆ FMS	SET
◆ Speed Bugs	SET
◆ TRIM Panel.....	__SET/ZERO/ZERO
◆ Doors & Windows	CLSD
◆ Takeoff Briefing.....	COMPLETED
◆ Fuel Pump Power	ON
◆ Red Beacon	ON
◆ Emergency/Parking Brake.....	AS RQRD
◆ Steering	AS RQRD
Safety Pins.....	ON BOARD

AFTER START

CHALLENGE	RESPONSE
Ground Equipment.....	REMOVED
ELECTRICAL Panel	SET
APU	AS RQRD
FADEC.....	RST/ALTN
Elec Hyd Pumps	AUTO
Windshield Heating.....	AS RQRD
AIR COND/PNEUM Panel	SET
FLAPS	__SET
Flight Controls	CKD
Taxi Lights	ON

NORMAL PROCEDURES

BEFORE TAKEOFF

CHALLENGE	ACTION/RESPONSE
Takeoff Briefing.....	PERFORM
Ice Protection Test.....	AS RQRD
Brakes Temperature	CKD
EICAS.....	CKD
Transponder	TA/RA
Takeoff Configuration.....	CKD
Gust Lock.....	UNLOCKED
Elevator.....	CKD

AFTER TAKEOFF

CHALLENGE	ACTION/RESPONSE
Landing Gear.....	UP
FLAPS.....	0
Thrust Rating	CLB
Windshield Heating.....	AS RQRD
AIR COND/PNEUM Panel.....	SET
Altimeters	SET/X-CKD
Pressurization	CKD
APU	AS RQRD

DESCENT

CHALLENGE	ACTION
Windshield Heating.....	PUSHED IN
Approach Briefing.....	COMPLETED
Speed Bugs	SET
PRESSURIZATION Panel.....	SET
-----	-----
External Lights.....	ON
Pax Signs.....	SET

APPROACH

CHALLENGE	ACTION/RESPONSE
PASS SIGNS Panel.....	SET
Altimeters	SET/X-CKD
Approach Aids.....	SET/X-CKD

BEFORE LANDING

CHALLENGE	ACTION
Landing Gear.....	DOWN
FLAPS.....	__ SET
Lights.....	AS RQRD
AP/YD.....	OFF

NORMAL PROCEDURES

SHUTDOWN

CHALLENGE	ACTION/RESPONSE
Thrust Levers	IDLE
Emergency/Parking Brake	SET
GPU/APU Generators	PUSHED IN
Shed Buses	AS RQRD
START/STOP Selectors.....	STOP
Red Beacon	OFF
FSTN BELTS	OFF
Fuel Pump Pwr	AS RQRD
Elec Hyd Pumps	OFF
Ice Protection Sys	OFF
AIR COND/PNEUM Panel	SET

LEAVING THE AIRPLANE

CHALLENGE	ACTION/RESPONSE
IRS (if applicable).....	OFF
Avionics Master 1 & 2	PUSHED OUT
Emergency Lights	OFF
External & Internal Lights.....	OFF
PAX SIGNS Panel	OFF
Weather Radar.....	OFF
Standby Attitude (if applicable).....	CAGED
GPU/APU.....	OFF
AIR COND/PNEUM Panel	SET
Fuel Pumps.....	OFF
Batteries	OFF

NORMAL PROCEDURES

INTENTIONALLY BLANK

User: aherrera - Printed By myTechCare - Jul 25/22 - 13:50:24

EMERGENCY/ABNORMAL PROCEDURES

INTRODUCTION

The Emergency/Abnormal Procedures published in the Quick Reference Handbook (QRH) are provided to pilots as quick guide to minimize the consequences of emergency and abnormal situations that might occur during airplane operation.

In case a discrepancy is found between the QRH and the approved Airplane Flight Manual (AFM), the AFM shall prevail.

Use the QRH requires proper training on the execution of all operational, emergency and abnormal procedures set forth in the AFM and a thorough knowledge of airplane systems.

The procedures set forth herein also require situational awareness for identification of an emergency or abnormal situations and pilot skills to guarantee safety. The Emergency Evacuation procedure accomplishment may be necessary in many situations and its need is at pilot's discretion.

It is EMBRAER recommendation that any unusual situation encountered should be reported as quickly as possible to Flight Operations and Maintenance Personnel.

Three blocks of procedures are contained in this manual:

- **Smoke Procedures:** address all annunciated and non annunciated smoke related procedures.
- **Non Annunciated Procedures:** procedures that are not related to an EICAS message but rather to a condition present in the airplane. The Checklists are arranged in alphabetical order with Emergency Checklists first, followed by Abnormal Checklists.
- **Annunciated Procedures:** procedures related to EICAS message. These procedures are grouped by system and the system tabs are in alphabetical order. Each title procedure is followed by the corresponding EICAS message identification. The Checklists for each System Tab are arranged in alphabetical order with the Emergency Checklists first followed by the Abnormal Checklists. The message provided for each procedure represents the root cause of the failure.

The emergency evacuation procedure is repeated in the last page of QRH, after Performance Data to make it easier to find.

EMERGENCY/ABNORMAL PROCEDURES

Some procedures can either be annunciated or non annunciated. In this case, the procedures are presented in the Annunciated block but are referenced in the Non Annunciated index.

In each Annunciated System Tab Index, the related non annunciated procedures are presented with a cross-reference to the Non Annunciated Tab page. The procedures index is classified into Emergency and Abnormal procedures, while EICAS Messages List is classified into Warning, Caution and Advisory messages.

Some EICAS messages do not have an associated QRH procedure. In those cases, "Crew Awareness" identifies the EICAS message as noted in the Index Table. If a Crew Awareness message is displayed on the EICAS, takeoff is prohibited, unless at least one of the following conditions is met:

- The message is an expected result of an intentional operation;
- Flight crew action is taken to clear the message;
- Maintenance personnel take action to clear the message;
- The airplane is dispatched in accordance with all approved company MEL provisions.

If one of the following Crew Awareness messages is presented after gate departure, the flight may continue only to the intended destination without further action:

- AHRs BASIC MODE,
- DU 1 (2, 3, 4, 5) FAN FAIL,
- E1 (2) OIL IMP BYP,
- ENG A/ICEOVERPRES,
- IC 1 (2) FAN FAIL or
- GEN 1 (2, 3, 4) BRG FAIL.

Some procedures include a characterization below the title if a relevant emergency/abnormal condition is present, such as aural warnings, lights, EICAS indications, flight instrument flags and the airplane condition itself.

The actions contained in the bold square boxes are recall items. They must be performed expeditiously, by memory.

Flying the airplane is always the priority in any emergency/abnormal situation. Checklists should be called after the flight path is under control, critical phases of flight (such as takeoff and landing) have ended and all recall items have been accomplished.

EMERGENCY/ABNORMAL PROCEDURES

Some emergency and abnormal situations require landing at the nearest suitable airport. This statement will be listed at the beginning of a task checklist to give the crew proper time to plan the landing. Also, as an aid for planning the diversion airport, the landing distance correction factor will be presented together with the “Land at nearest suitable airport” statement.

Throughout this manual, a text followed by () means that either condition applies. A text followed by “-” means that both conditions apply simultaneously.

Some procedures require depressurizing the cabin. This will require either dumping the cabin air or the use of manual control to accomplish this task. In this situation, manual control depressurization is the recommended method to be used for passenger comfort and should be made by setting the pressurization mode selector to MAN and smoothly setting the controller to FULL UP. When there is a need to depressurize by a specific method, it will be clearly stated in the procedure.

The procedures contained herein assume that:

- Airplane systems were operating normally prior to the failure.
- All emergency/abnormal actions are performed in the order they are listed in the procedure.
- Normal procedures have been properly performed.
- Aural warnings are silenced as necessary. Master Warning/Caution lights are reset as soon as the failure is recognized.
- All procedures are self-contained. All other messages that may be generated by a single failure do not require that procedures associated to those messages be accomplished in addition to the procedure addressing the root cause.
- Circuit breakers must not be pushed in if they pop up.

All assigned tasks in the procedures have the indication END at the completion of each assigned task. No task is over until **END** has been reached.

Upon completion of the checklist the pilot reading it should state: “(Procedure Title) Checklist Complete”.

In the event of multiple failures (excluding cascade failures) with different landing configuration and/or landing distance correction factors, the crew should use good judgment to determine the safest action.

EMERGENCY/ABNORMAL PROCEDURES

According to the QRH philosophy, Rejected Takeoff (at or below V_1) procedure is not considered in this manual. Indeed, should the flight crew decide to reject the takeoff; they will do it by memory, not by referring to the QRH. Consequently, Rejected Takeoff (at or below V_1) procedure is a matter of flight crew training and is considered within the Standard Operating Procedures Manual, which contains the complete guidance to accomplish it.

Indentation exists when the information is displaced to the right relative to the paragraph that immediately precedes it. The indentation is used to establish a relationship between the indented and the preceding information. An indented information is normally preceded by a condition (e.g. “during landing”, “if something is true”, “when something happens”). When this is the case, observe the indented information when the preceding condition is satisfied.

TABLE OF CONTENTS

BAGGAGE SMOKE.....	S-3
LAVATORY SMOKE	S-3
SMOKE EVACUATION	S-4
SMOKE / FIRE / FUMES.....	S-6

User: aherrera - Printed By myTechCare - Jul 25/22 - 13:50:24

EMERGENCY/ABNORMAL PROCEDURES

Smoke

LIST OF EICAS MESSAGES

BAGG SMOKE S-3

LAV SMOKE S-3

BAGGAGE SMOKE

EICAS Warning: BAGG SMOKE

**Fire Extg Bagg
Button (if installed)..... PUSH IN**

LAND AT THE NEAREST SUITABLE AIRPORT.

Shed Buses OFF

Altitude MAINTAIN

Delay the descent as long as possible.

NOTE: Advise Ground Crew of possible Halon vapors approximately 50 minutes after discharging fire extinguishing bottle.

END

LAVATORY SMOKE

EICAS Warning: LAV SMOKE (may be presented)

Lavatory Flush and Lavatory Light CB's (Located in Line E) PULL

Establish contact with the cabin crew.

If necessary:

Diversion CONSIDER

SMOKE EVACUATION

Procedure (S-4) ACCOMPLISH

END

Smoke

SMOKE EVACUATION

Condition: Smoke or odor inside the cabin and/or cockpit requiring smoke removal.

Crew Oxygen Masks.....DON, 100%
Smoke Goggles.....DON
Crew Communication....ESTABLISH

LAND AT THE NEAREST SUITABLE AIRPORT.

Cockpit Door CLOSE

Reinforced Cockpit Door Louver Vent (if applicable) CLOSE

Recirculation Fan..... PUSH OUT

Gasper Fan PUSH OUT

Pressurization Manual Controller 1 O'CLOCK POSITION

 **WAIT 15 SECONDS**

Pressurization Mode Selector PUSH IN (MAN)

Passenger Oxygen AS REQUIRED

CONTINUES ON NEXT PAGE

User: aherrera - Printed By myTechCare - Jul 25/22 - 13:50:24

CONTINUED FROM PREVIOUS PAGE

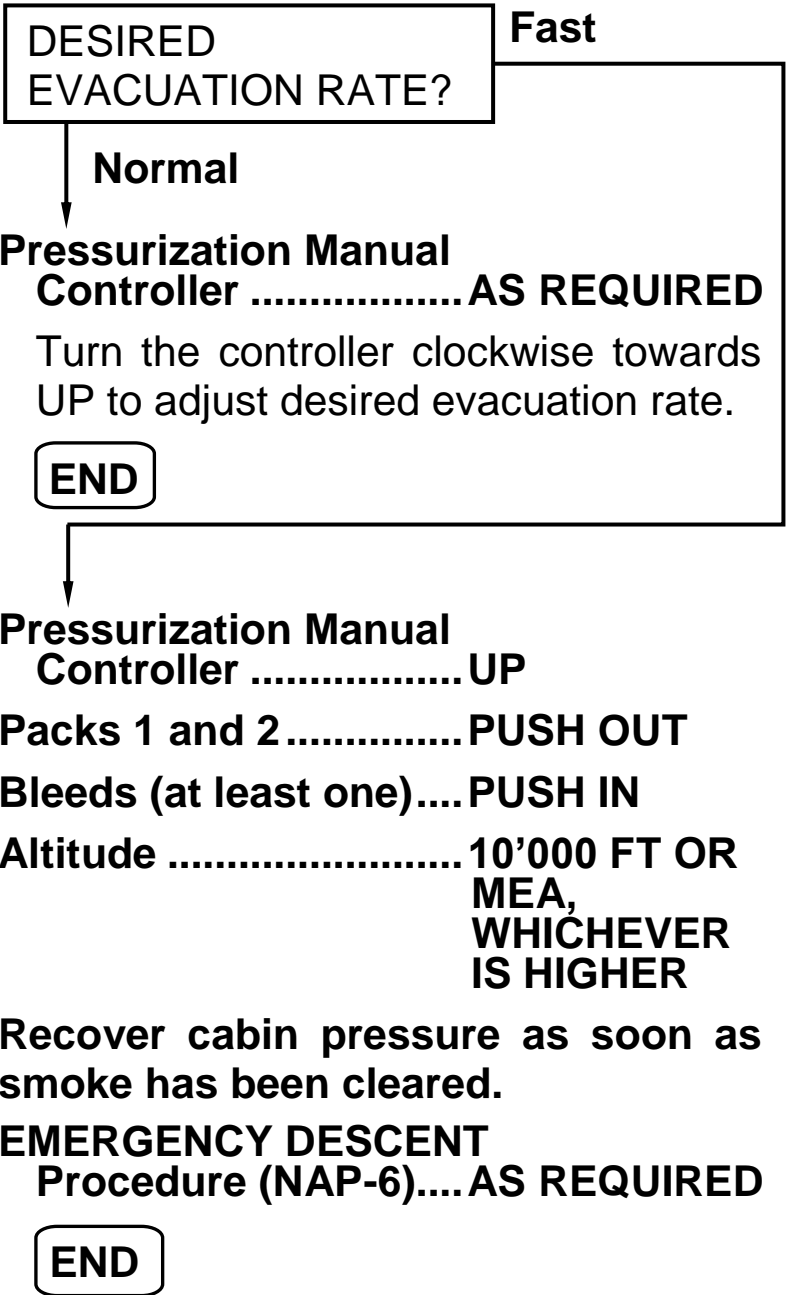

User: aherrera - Printed By myTechCare - Jul 25/22 - 13:50:24

EMERGENCY/ABNORMAL PROCEDURES

Smoke

SMOKE / FIRE / FUMES

Condition: Smoke fire or fumes visually confirmed or identified by odor without an EICAS warning.

Crew Oxygen Masks.....DON, 100%
Smoke Goggles.....DON
Crew Communication....ESTABLISH

LAND AT THE NEAREST SUITABLE AIRPORT.

Recirculation Fan.....PUSH OUT

Gasper FanPUSH OUT

NOTE: Any time smoke becomes dense, perform **SMOKE EVACUATION Procedure(S-4).**

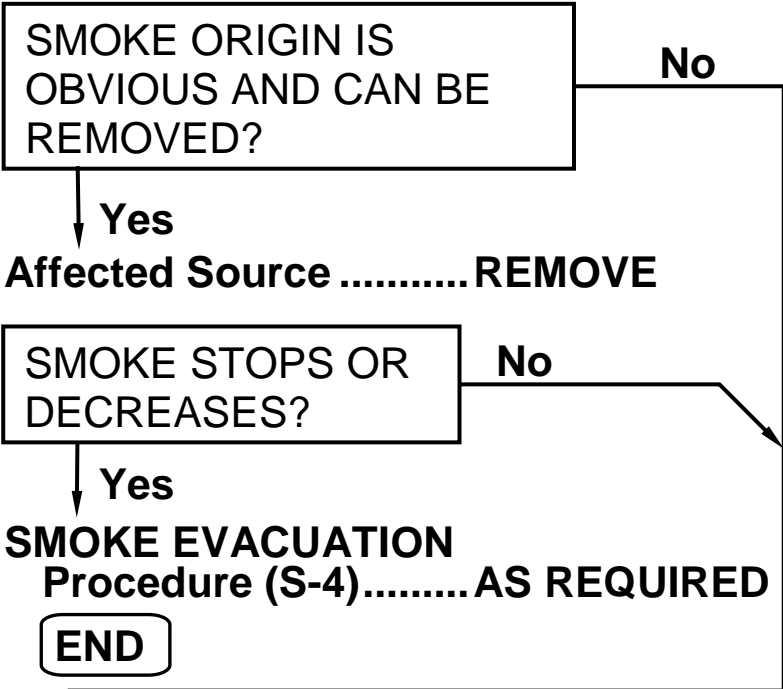

Cabin Crew NOTIFY
FSTN Belts..... ON

CONTINUES ON NEXT PAGE

User: aherrera - Printed By myTechCare - Jul 25/22 - 13:50:24

QRH-145/1115

Smoke

CONTINUED FROM PREVIOUS PAGE

- Thrust Levers IDLE**
- Speed Brakes OPEN**
- Airspeed MAX 250 KIAS**
- Landing Gear DOWN**
- Altitude 10'000 FT OR
MEA,
WHICHEVER
IS HIGHER**

- Transponder 7700**
- ATC NOTIFY**
- Cockpit Door CLOSE**

- Reinforced Cockpit Door
Louver Vent
(if applicable) CLOSE**

- Pressurization
Manual Controller 1 O'CLOCK
POSITION**



- WAIT 15
SECONDS**

- Pressurization Mode
Selector PUSH IN (MAN)**

- Passenger Oxygen AS REQUIRED**

- Pressurization Manual
Controller FULL UP**

- Packs 1 and 2 PUSH OUT**

- Shed Buses OFF**

- Bus Ties OFF**

- VTRL PUMP SEL
(if applicable) SET TO A**

CONTINUES ON NEXT PAGE

EMERGENCY/ABNORMAL PROCEDURES

Smoke

CONTINUED FROM PREVIOUS PAGE

Fuel Pump 1 1A OR 1C

Fuel Pump 2 2B

Battery 2 OFF

Generators 2 and 4 PUSH OUT

Shed Buses, Central DC Bus, DC Bus 2 and Essential Bus 2 deenergized.

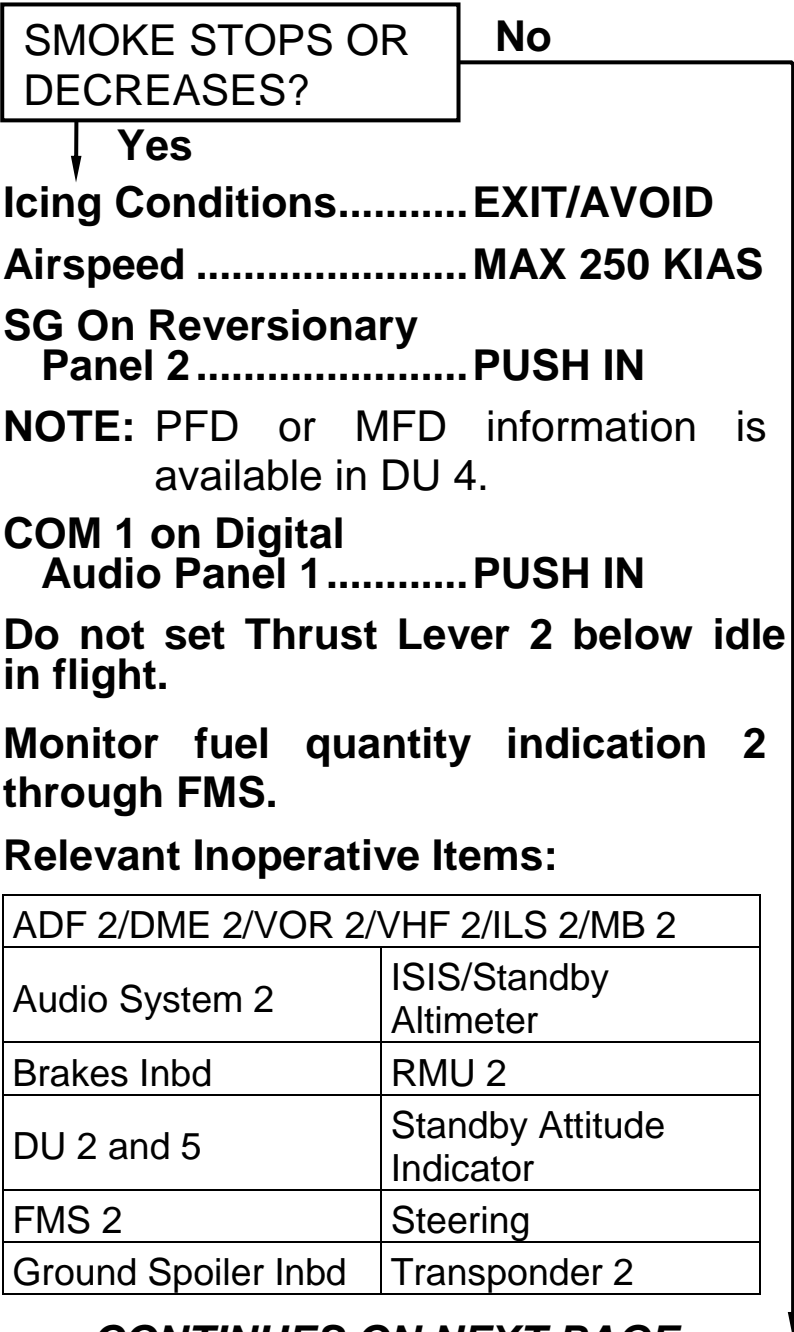

CONTINUES ON NEXT PAGE

User: aherrera - Printed By myTechCare - Jul 25/22 - 13:50:24

CONTINUED FROM PREVIOUS PAGE

NOTE: Landing gear lever can not be moved up.

Landing configuration:

Anticipate flap slower actuation.

If landing gear has not been selected down:

**Gear Electrical
OverrideDOORS**

**WAIT 3
SECONDS**

**Gear Electrical
OverrideGEAR/DOORS**

Flaps45°

**V_{REF}V_{REF} 45° +
5 KIAS**

**CAUTION:MULTIPLY THE FLAPS
45° UNFACTORED
LANDING DISTANCE BY
1.95.**

Do not actuate Thrust Reverser 2.

Brake effectiveness will be reduced.

END

**IS SUITABLE
AIRPORT DISTANT?**

No

Yes

Generators 2 and 4PUSH IN

Battery 2AUTO

CONTINUES ON NEXT PAGE

QRH-145/1115

User: aherrera - Printed By myTechCare - Jul 25/22 - 13:50:24

EMERGENCY/ABNORMAL PROCEDURES

Smoke

CONTINUED FROM PREVIOUS PAGE

Fuel Pump 11B

Fuel Pump 22A OR 2C

**VTRL PUMP SEL
(if applicable)SET TO B**

Battery 1OFF

Generators 1 and 3PUSH OUT
Shed Buses, Central DC Bus, DC Bus 1 and
Essential Bus 1 deenergized.

Emergency lightsOFF

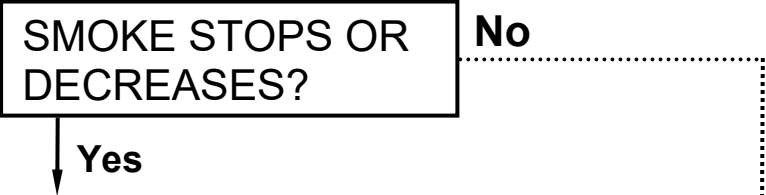

Icing ConditionsEXIT/AVOID

**SG On Reversionary
Panel 1PUSH IN**

NOTE: PFD or MFD information is available in DU 2.

**COM 2 on Digital
Audio Panel 2PUSH IN**

Do not set Thrust Lever 1 below idle in flight.

Monitor fuel quantity indication 1 through FMS.

CONTINUES ON NEXT PAGE

User: aherrera - Printed By myTechCare - Jul 25/22 - 13:50:24



QRH-145/1115

CONTINUED FROM PREVIOUS PAGE

Relevant Inoperative Items:

ADF 1/DME 1/VOR 1/VHF 1/ILS 1/MB 1	
Audio System 1	Ground Spoiler Outbd
Autopilot	Main Pitch Trim
Brakes Outbd	RMU 1
DU 1 and 4	Speed Brake
FMS 1	Transponder 1

NOTE: Landing gear lever can only be moved up using downlock release button (DN Lock Rel).

Landing configuration:

Anticipate flap slower actuation.

Emergency lightsON

Flaps45°

V_{REF}V_{REF} 45° + 5 KIAS

CAUTION: MULTIPLY THE FLAPS 45° UNFACTORED LANDING DISTANCE BY 1.95.

Do not actuate Thrust Reverser 1.

Brake effectiveness will be reduced.

END

Generators 1 and 3PUSH IN

Battery 1AUTO

Backup BatteryPUSH OUT

WARNING: CONSIDER AN IMMEDIATE LANDING.

CONTINUES ON NEXT PAGE

QRH-145/1115

User: aherrera - Printed By myTechCare - Jul 25/22 - 13:50:24

EMERGENCY/ABNORMAL PROCEDURES

Smoke

CONTINUED FROM PREVIOUS PAGE

Landing configuration:

Emergency lights.....ON

Flaps45°

V_{REF}V_{REF} 45°

END

Icing Conditions.....EXIT/AVOID

AirspeedMAX 250 KIAS

SG On Reversionary

Panel 2.....PUSH IN

NOTE: PFD or MFD information is available in DU 4.

COM 1 on Digital

Audio Panel 1.....PUSH IN

Do not set Thrust Lever 2 below idle in flight.

Monitor fuel quantity indication 2 through FMS.

Relevant Inoperative Items:

ADF 2/DME 2/VOR 2/VHF 2/ILS 2/MB 2	
Audio System 2	ISIS/Standby Altimeter
Brakes Inbd	RMU 2
DU 2 and 5	Standby Attitude Indicator
FMS 2	Steering
Ground Spoiler Inbd	Transponder 2

NOTE: Landing gear lever can not be moved up.

CONTINUES ON NEXT PAGE

Smoke

CONTINUED FROM PREVIOUS PAGE

Landing configuration:

Anticipate flap slower actuation.

If landing gear has not been selected down:

**Gear Electrical
OverrideDOORS**



..... **Wait 3**

SECONDS

**Gear Electrical
OverrideGEAR/DOORS**

Flaps45°

**V_{REF}V_{REF45°} +
5 KIAS**

**CAUTION:MULTIPLY THE FLAPS
45° UNFACTORED
LANDING DISTANCE
BY 1.95.**

Do not actuate Thrust Reverser 2.

Brake effectiveness will be reduced.

END

User: aherrera - Printed By myTechCare - Jul 25/22 - 13:50:24

QRH-145/1115

EMERGENCY/ABNORMAL PROCEDURES

Smoke

INTENTIONALLY BLANK

User: aherrera - Printed By myTechCare - Jul 25/22 - 13:50:24

TABLE OF CONTENTS

AILERON RUNAWAY	NAP-3
AIRPLANE OVERSPEED	NAP-4
APU OVERTEMPERATURE	NAP-4
DITCHING	NAP-5
DUAL ENGINE FAILURE	refer to EAP 6-3
EMERGENCY DESCENT	NAP-6
EMERGENCY EVACUATION	NAP-6
ENGINE FIRE, SEVERE DAMAGE OR SEPARATION	refer to EAP 6-6
ENGINE OIL LOW PRESSURE	refer to EAP 6-7
FORCED LANDING	NAP-7
FUEL LEAK	NAP-8
INADVERTENT SPOILER OPEN	refer to EAP 8-3
JAMMED AILERON	NAP-8A
JAMMED ELEVATOR	NAP-8A
JAMMED RUDDER	NAP-9
PITCH TRIM INOPERATIVE	refer to EAP 8-4
PITCH TRIM RUNAWAY	NAP-10
RAPID CABIN DEPRESSURIZATION	NAP-11
ROLL TRIM RUNAWAY	NAP-3
SMOKE EVACUATION	refer to S-4
SMOKE / FIRE / FUMES	refer to S-6
ABNORMAL ENGINE START	NAP-12
ABNORMAL LANDING GEAR EXTENSION	NAP-13
ADS-B OUT FAIL OR DEGRADED	NAP-14
AILERON ARTIFICIAL FEEL INOPERATIVE	NAP-14
APPROACH WARNING	NAP-14
ASYMMETRIC RUDDER OPERATION	NAP-14
CABIN DEPRESSURIZATION	refer to EAP 1-13
CABIN RATE ABNORMAL FLUCTUATIONS	refer to EAP 1-13
CAS MESSAGE MISCOMPARISON	NAP-14
CDU DATA BUS FAIL FMS ANNUNCIATION	NAP-15
CRACKED WINDSHIELD	NAP-24
DISPLAY FAILURE	refer to EAP 2-8
EMERGENCY/PARKING BRAKE HANDLE DISAGREE	NAP-15
ENGINE ABNORMAL VIBRATION	NAP-15
ENGINE AIRSTART	NAP-16

CONTINUES ON NEXT PAGE

EMERGENCY/ABNORMAL PROCEDURES

Non Annunciated

CONTINUED FROM PREVIOUS PAGE

ENGINE CONTROL FAILURE.....	refer to EAP 6-9
ENGINE FAILURE/SHUTDOWN	NAP-19
ENGINE HIGH OIL PRESSURE	NAP-20
ENGINE HIGH OIL TEMPERATURE.....	NAP-20
ENGINE LOW OIL LEVEL	NAP-20
ENGINE OIL LOW PRESSURE	NAP-20
ENGINE OVERTEMPERATURE	NAP-21
ENGINE TAILPIPE FIRE	NAP-21
ERRONEOUS STALL PROTECTION ACTUATION	NAP-22
GEAR LEVER CANNOT MOVE UP AFTER TAKEOFF	NAP-22
GUST LOCK FAILURE	NAP-23
IC BUS FAILURE	refer to EAP 2-11
IC FAILURE	refer to EAP 2-11
IMPAIRED OR CRACKED WINDSHIELD	NAP-24
IRS/MSU FAILURE ANNUNCIATION.....	NAP-25
LOSS OF ENGINE INDICATIONS.....	NAP-26
LOSS OF PRESSURIZATION INDICATION	NAP-27
MAIN DOOR BLOCKED	NAP-28
NAV/FLIGHT INSTRUMENTS FAILURE	NAP-28
NOSE LANDING GEAR UP DOOR OPEN	NAP-30
ONE ENGINE INOPERATIVE APPROACH AND LANDING.....	NAP-30
OVERWEIGHT LANDING.....	NAP-31
OXYGEN LEAKAGE	NAP-31
PARTIAL OR GEAR UP LANDING.....	NAP-32
PRESSURIZATION AUTOMATIC SYSTEM FAILURE	refer to EAP 1-13
RADIO ALTIMETER FAIL	refer to EAP 2-16
RUDDER ARTIFICIAL FEEL INOPERATIVE	NAP-33
RUDDER RUNAWAY	NAP-33
SINGLE ENGINE BLEED OPERATION IN ICING CONDITIONS	NAP-34
STEERING SYSTEM INOPERATIVE	refer to EAP 12-7
STIFFENED ELEVATOR	NAP-35
STRUCTURAL DAMAGE.....	NAP-36
TRANSPONDER FAIL	NAP-36
UNCOMMANDED AILERON DISCONNECTION .	NAP-36

CONTINUES ON NEXT PAGE

EMERGENCY/ABNORMAL PROCEDURES

Non Annunciated

CONTINUED FROM PREVIOUS PAGE

UNCOMMANDED	
ELEVATOR DISCONNECTION	NAP-36
UNCOMMANDED SWERVING	
ON GROUND.....	refer to EAP 12-7
UNRELIABLE AIRSPEED	NAP-37
VOLCANIC ASH	NAP-38
YAW TRIM RUNAWAY	NAP-33

User: aherrera - Printed By myTechCare - Jul 25/22 - 13:50:24

EMERGENCY/ABNORMAL PROCEDURES

Non Annunciated

INTENTIONALLY BLANK

AILERON RUNAWAY/ ROLL TRIM RUNAWAY

Condition: Sudden roll.

Quick Disconnect Button.....PRESS AND HOLD
Aileron Shutoff 1 and 2PUSH OUT

Roll Trim CB (F23)PULL
Quick Disconnect Button.....RELEASE
AirspeedMAX 250 KIAS
Roll Trim Position.....CHECK

ROLL TRIM IN NEUTRAL POSITION?

No

Yes

Roll Trim CB (F23)PUSH
Prepare to overcome uncommanded roll.
Aileron Shutoff 1.....PUSH IN

RUNAWAY PERSISTS?

No

Yes

Aileron Shutoff 1.....PUSH OUT
Prepare to overcome uncommanded roll.
Aileron Shutoff 2.....PUSH IN

RUNAWAY STILL PERSISTS?

No

Yes

Aileron Shutoff 2.....PUSH OUT
 Expect greater aileron control force. If required, both pilots should act together to control airplane.
Avoid airports with anticipated turbulence or crosswind.
Perform a long final approach.
Landing configuration:

Landing GearDOWN
Flaps22°
V_{REF}.....V_{REF45} + 30 KIAS

CAUTION: MULTIPLY THE FLAPS 45° UNFACTORED LANDING DISTANCE BY 1.85.

END

Aileron Shutoff 1 and 2PUSH IN
Roll trim is inoperative. Use aileron and rudder to control the airplane.

END

User: aherrera - Printed By myTechCare - Jul 25/22 - 13:50:24

EMERGENCY/ABNORMAL PROCEDURES

Non Annunciated

AIRPLANE OVERSPEED

Aural Warning: Voice Message HIGHSPEED

INDICATION: Airspeed and Mach indications in red range.

Airspeed.....MAX V_{MO}/M_{MO}

END

APU OVERTEMPERATURE

EICAS Indication: EGT enter amber or red range.

EICAS Caution: APU FAIL may be presented.

APU BleedPUSH OUT



.....WAIT 10 SECONDS

EGT REMAINS HIGH?

No

Yes

APU Fuel Shutoff Button.....PUSH IN

APU Master Knob.....OFF

CAUTION: DO NOT ATTEMPT TO RESTART APU.

END

Consider the APU shutdown if it is not necessary.

END

User: aherrera - Printed By myTechCare - Jul 25/22 - 13:50:24

DITCHING

- ATC NOTIFY
- Transponder 7700
- FSTN Belts ON
- Cabin Crew NOTIFY
- Passengers (and Crew) PREPARE FOR DITCHING

Below 10'000 ft:

- Pressurization Dump Button PUSH IN (ON)
- GPWS CB (J7 or J8) PULL
- Aural Warn CBs (B4 and E30) PULL
- Emerg Lts ON
- ELT ON

At 1'000 ft:

- VTRL TK XFER (if applicable) OFF
- Packs 1 and 2 PUSH OUT
- Engine Bleeds 1 and 2 PUSH OUT

Plan ditching parallel to the line of the wave crests. On final, level the wings and avoid skidding. Touchdown with 4° nose up attitude, and rate of descent less than 180 ft/min.

Ditching configuration:

- Landing Gear UP
- Flaps 45°

If it is not possible to achieve the selected flap position, maintain airspeed according to the following:

FLAPS POSITION	MIN AIRSPEED
0 to 8°	$V_{REF45} + 30$ KIAS
9° to 21°	$V_{REF45} + 10$ KIAS
22° to 44°	$V_{REF45} + 5$ KIAS
45°	V_{REF45}

Just before touchdown:

- Cabin ANNOUNCE IMPACT

WARNING: USE ONLY OVERWING EMERGENCY EXITS FOR PASSENGER EVACUATION. DO NOT OPEN REMAINING DOORS.

Upon water contact:

- Thrust Levers 1 and 2 IDLE
- Start/Stop Selectors 1 and 2 STOP
- APU SHUTDOWN
- Fire Extinguishing Handles PULL
- APU Fuel Shutoff Button PUSH IN
- Engine and APU Fire Extinguishing Bottles (if necessary) DISCHARGE
- Fuel Pumps Pwr OFF
- Hydraulic Elec Pumps OFF
- EMERGENCY EVACUATION Procedure ACCOMPLISH

Before leaving the airplane:

- Batteries 1 and 2 OFF

END

User: aherrera - Printed By myTechCare - Jul 25/22 - 13:50:24

QRH-145/1115

EMERGENCY/ABNORMAL PROCEDURES

Non Annunciated

EMERGENCY DESCENT

Cabin Crew	NOTIFY
FSTN Belts.....	ON
Thrust Levers	IDLE
Speed Brakes	OPEN
Airspeed	MAX 250 KIAS
Landing Gear.....	DOWN
Descent.....	INITIATE
Altitude	MEA OR 10'000 FT, WHICHEVER IS HIGHER

Transponder

7700

ATC.....NOTIFY

CAUTION: IF STRUCTURAL DAMAGE IS SUSPECTED,
USE THE FLIGHT CONTROLS WITH CAUTION
AVOIDING HIGH MANEUVERING LOADS AND
REDUCING AIRSPEED AS APPROPRIATE.

END

EMERGENCY EVACUATION

Parking Brake

APPLY

Cabin.....

DEPRESSURIZE

Fire Extinguishing Handles

PULL

APU Fuel Shutoff Button

PUSH IN

Engines and APU Fire Extinguishing
Bottles (if necessary).....

DISCHARGE

VTRL TK XFER (if applicable)

OFF

Fuel Pumps Pwr 1 and 2.....

OFF

Hydraulic Elec Pumps 1 and 2

OFF

Cabin Crew.....

NOTIFY

Emerg Lts.....

ON

EMERGENCY EVACUATION
Procedure.....

ACCOMPLISH

ATC.....

NOTIFY

Before leaving the airplane:
Batteries 1 and 2.....

OFF

END

FORCED LANDING

- ATC NOTIFY
- Transponder..... 7700
- FSTN Belts..... ON
- Cabin Crew NOTIFY
- Passengers (and Crew)..... **PREPARE FOR FORCED LANDING**

Below 10'000 ft:

- Pressurization Dump Button..... PUSH IN (ON)
- GPWS CB (J7 or J8) PULL
- Aural Warn CBs (B4 and E30) PULL
- Emerg Lts ON
- ELT ON

When committed to land:

Landing Gear AS REQUIRED

The decision to land with all gear up or with any gear extended is left to pilots. The choice of configuration is based on the number of gear available, airplane load distribution, controllability and conditions of the landing field. Ground spoilers and thrust reversers will not operate if any main gear is up.

Flaps 45°

If it is not possible to achieve the selected flap position, maintain airspeed according to the following:

FLAPS POSITION	MIN AIRSPEED
0 to 8°	V _{REF45} + 30 KIAS
9° to 21°	V _{REF45} + 10 KIAS
22° to 44°	V _{REF45} + 5 KIAS
45°	V _{REF45}

Just before touchdown:

- Cabin..... **ANNOUNCE IMPACT**
- Fire Extinguishing Handles PULL
- APU Fuel Shutoff Button PUSH IN
- VTRL TK XFER (if applicable) OFF

When the airplane stops:

- Engines and APU Fire Extinguishing Bottles (if necessary)..... DISCHARGE
- Fuel Pumps Pwr 1 and 2 OFF
- Hydraulic Elec Pumps 1 and 2 OFF

EMERGENCY EVACUATION

Procedure..... **ACCOMPLISH**

Before leaving the airplane:

- Batteries 1 and 2..... OFF

END

User: aherrera - Printed By myTechCare - Jul 25/22 - 13:50:24

EMERGENCY/ABNORMAL PROCEDURES

Non Annunciated

FUEL LEAK

- Condition:**
- FMS Fuel Remaining quantity is above the MFD or EICAS total fuel indication.
 - Excessive Fuel flow from one of the engines.
 - Fuel imbalance develops.
 - Fuel quantity of a tank decreases at an abnormal rate.

LAND AT THE NEAREST SUITABLE AIRPORT.

XFEEDOFF

Affected Fuel TankIDENTIFY

Asymmetric ThrustAS REQUIRED

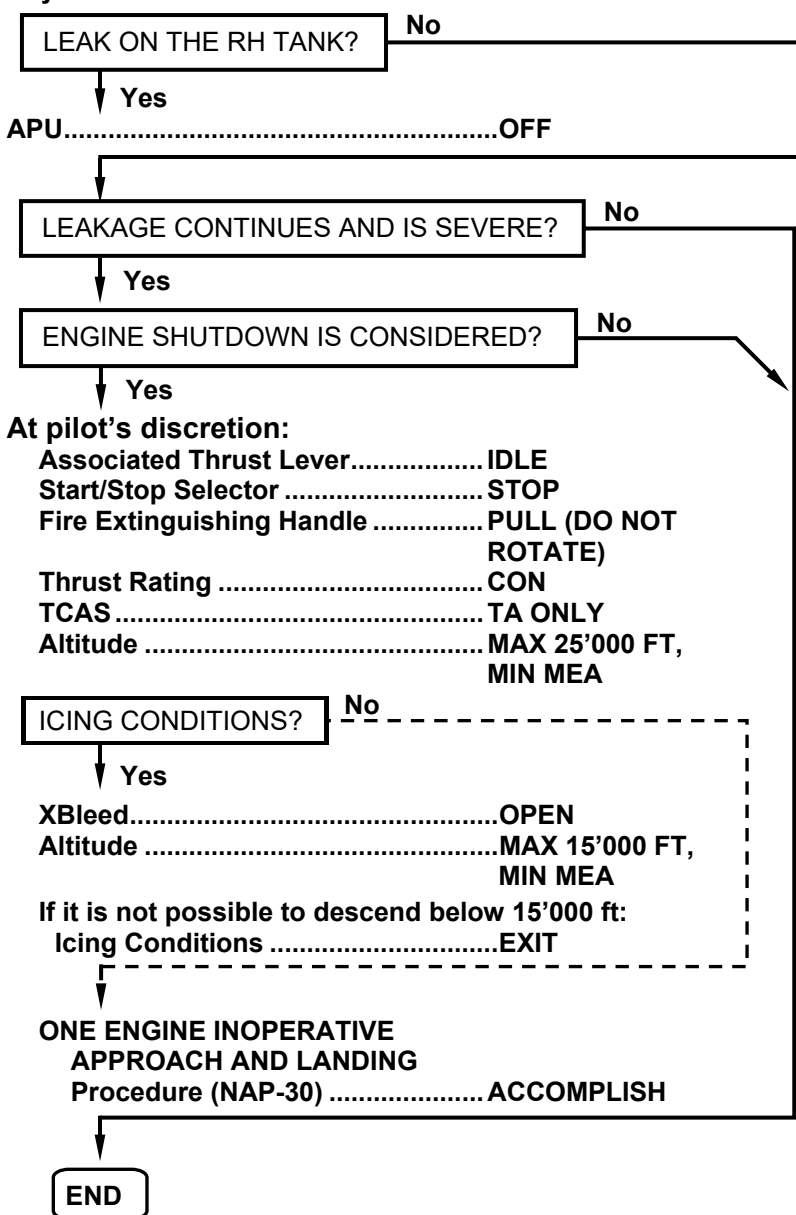

JAMMED AILERON

Condition: Both control wheels can not be moved to either side.

Aileron Disconnection Handle..... PRESS AND PULL

Autopilot **DISENGAGE**

Airspeed **MAX 200 KIAS**

If the right control wheel is jammed, roll trim and artificial feel are not available.

Maintain bank angle below 20°.

If both ailerons are jammed, use rudder to control the airplane.

Avoid abrupt and large aileron inputs.

Avoid airports with anticipated turbulence or crosswind.

Landing configuration:

Flaps **45°**

V_{REF}..... **V_{REF45} + 5 KIAS**

CAUTION: MULTIPLY THE FLAPS 45° UNFACTORED LANDING DISTANCE BY 1.10.

END

JAMMED ELEVATOR

Condition: Both control columns can not be moved either forward or backward.

EICAS Warning: SPS 1-2 INOP may be presented.

EICAS Caution: STICK PUSHER FAIL may be presented.

Elevator Disconnection Handle..... PRESS AND PULL

Autopilot **DISENGAGE**

Airspeed **MAX 200 KIAS**

Pitch Trim **AS REQUIRED**

Avoid airports with anticipated turbulence or crosswind.

Landing configuration:

Flaps **22°**

V_{REF}..... **V_{REF45} + 10 KIAS**

If both elevators are jammed, pitch trim may be used to land the airplane.

If left elevator is jammed, Stick Pusher will not be available.

Elevator authority to flare during landing may be reduced.

Do not reengage autopilot.

CAUTION: MULTIPLY THE FLAPS 45° UNFACTORED LANDING DISTANCE BY 1.45.

END

User: aherrera - Printed By myTechCare - Jul 25/22 - 13:50:24

EMERGENCY/ABNORMAL PROCEDURES

Non Annunciated

INTENTIONALLY BLANK

User: aherrera - Printed By myTechCare - Jul 25/22 - 13:50:24

JAMMED RUDDER

Condition: Pedals can not be moved.

Command rudder through yaw trim.

If required, use asymmetric thrust to control the airplane. Maintain engine asymmetric thrust until nose gear contact in order to avoid lateral and directional miscontrol.

Rudder Shutoff Sys 2 PUSH OUT

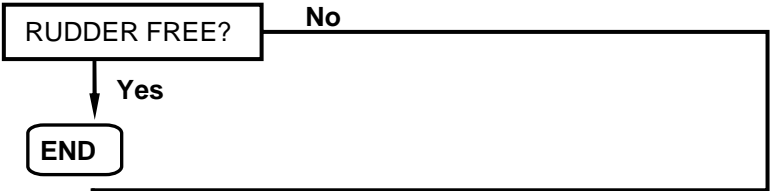

**Rudder Shutoff Sys 2 PUSH IN
Rudder Shutoff Sys 1 PUSH OUT**

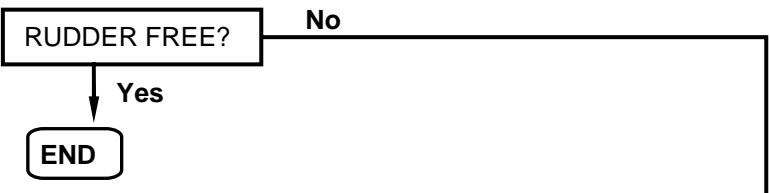

**Airspeed MAX 200 KIAS
Avoid airports with anticipated turbulence or crosswind.
During final approach and landing run:**

Pilot not flying:

Steering Disengage Button PRESS AND HOLD

Steering Handle AS REQUIRED

Use Steering Handle still keeping the Steering Disengage Button pressed.

CAUTION: DO NOT RELEASE THE NOSEWHEEL STEERING HANDLE UNTIL THE AIRPLANE IS COMPLETELY STOPPED.

Thrust Levers IDLE

If necessary, use differential braking to steer the airplane.

Landing configuration:

Flaps 22°

V_{REF} V_{REF45} + 5 KIAS

CAUTION: MULTIPLY THE FLAPS 45° UNFACTORED LANDING DISTANCE BY 1.62.

END

User: aherrera - Printed By myTechCare - Jul 25/22 - 13:50:24

EMERGENCY/ABNORMAL PROCEDURES

Non Annunciated

PITCH TRIM RUNAWAY

Condition: Uncommanded pitch and trim indication changes.

EICAS Warning: AUTOPILOT FAIL may be presented.

EICAS Caution: AUTO TRIM FAIL may be presented.

Quick Disconnect ButtonPRESS AND HOLD

NOTE: Do not change flap setting.

At safe altitude:

Pitch Trim Main Sys CutoutPUSH OUT

Pitch Trim Backup Sys CutoutPUSH OUT

Quick Disconnect ButtonRELEASE

WARNING: DO NOT OPEN SPEED BRAKE.

Prepare to overcome unwanted pitch change.

Pitch Trim Backup Sys CutoutPUSH IN

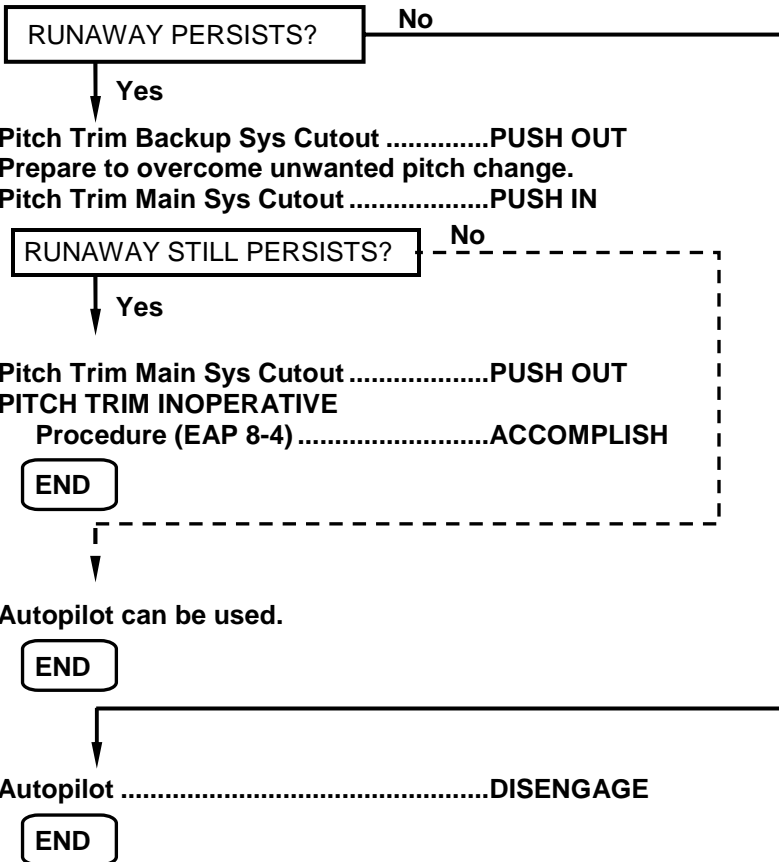

RAPID CABIN DEPRESSURIZATION

Aural Warning: Voice Message **CABIN**
EICAS Indication: CAB ALT Value in red
Condition: Cabin altitude has exceeded 10'000 ft.

- Crew Oxygen Masks..... DON**
- Crew Communication..... ESTABLISH**
- If Emergency Descent is necessary:**
 - Cabin Crew NOTIFY**
 - FSTN Belts ON**
 - Thrust Levers..... IDLE**
 - Speed Brakes..... OPEN**
 - Airspeed MAX 250 KIAS**
 - Landing Gear DOWN**
 - Descent..... INITIATE**
 - Altitude MEA OR 10'000 FT,
WHICHEVER IS
HIGHER**

CAUTION: IF STRUCTURAL DAMAGE IS SUSPECTED, USE THE FLIGHT CONTROLS WITH CAUTION AVOIDING HIGH MANEUVERING LOADS AND REDUCING AIRSPEED AS APPROPRIATE.

Passenger Oxygen AS REQUIRED
**Altitude MEA OR 10'000 FT,
WHICHEVER IS
HIGHER**

END

EMERGENCY/ABNORMAL PROCEDURES

Non Annunciated

ABNORMAL ENGINE START

Condition: Any abnormal engine indication during engine start.

To abort start:

Associated Thrust LeverIDLE

Associated Start/Stop SelectorSTOP

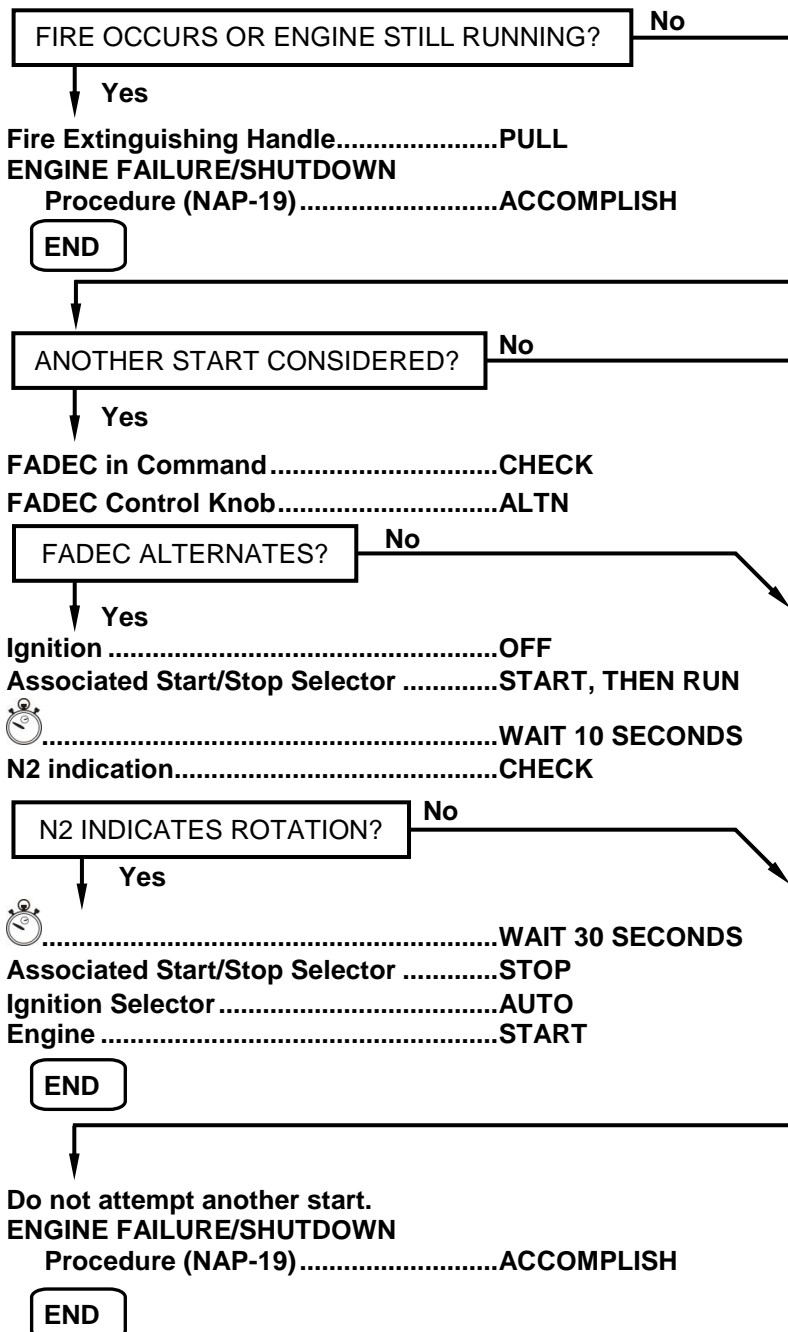

User: aherrera - Printed By myTechCare - Jul 25/22 - 13:50:24

ABNORMAL LANDING GEAR EXTENSION

Condition: Landing gear has not extended by normal means.

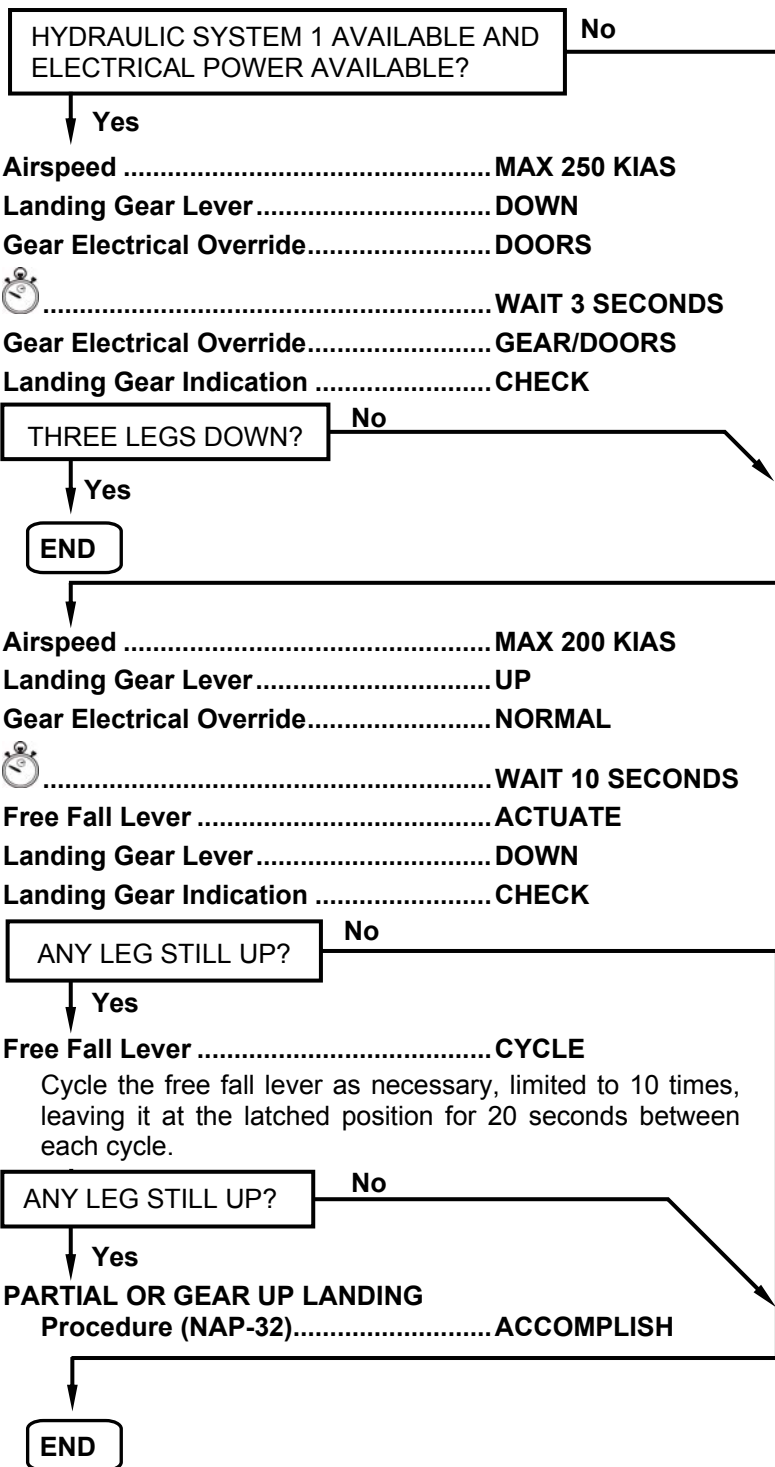

User: aherrera - Printed By myTechCare - Jul 25/22 - 13:50:24

EMERGENCY/ABNORMAL PROCEDURES

Non Annunciated

ADS-B OUT FAIL OR DEGRADED

Condition: ADS-B FAIL or ADS-B DGR annunciation displayed on the RMU Radio page or by ATC notification.

Transponder**SELECT ANOTHER**

END

AILERON ARTIFICIAL FEEL INOPERATIVE

Condition: Control Wheel excessively light and oversensitive.

Airspeed.....**MAX 200 KIAS**

Do not make abrupt and large aileron inputs.

END

APPROACH WARNING

Combiner Message: APCH WARN

MISSED APPROACH Procedure.....**PERFORM**

A Missed Approach Procedure must be performed, unless the approach is continued under visual conditions and the airplane position and attitude assure a safe landing.

In this case, the All guidance must not be followed.

END

ASYMMETRIC RUDDER OPERATION

Condition: Rudder pedals heavier to be moved to one side than the other.

Rudder Shutoff Sys 2**PUSH OUT**

If the failure persists:

Rudder Shutoff Sys 2**PUSH IN**

END

CAS MESSAGE MISCOMPARISON

PFD Indication: CAS MSG in amber.

MFD Knob on Reversionary Panel 1**EICAS**

MFD Knob on Reversionary Panel 2**EICAS**

Pilot's/Copilot's EICAS Messages**COMPARE**

Discrepant Message**CHECK**

Analyze the situation to check whether the discrepant message is spurious or not, and take the appropriate corrective action.

END

EMERGENCY/ABNORMAL PROCEDURES

Non Annunciated

CDU DATA BUS FAIL FMS ANNUNCIATION

Condition: Affected FMS is not updating CDU.
CDU DATA BUS FAIL message presented on FMS (UNS-1K).

Affected FMS..... OFF, then ON

Power down the FMS using the ON-OFF DIM key.

DO NOT use the circuit breaker to cycle power to the FMS.

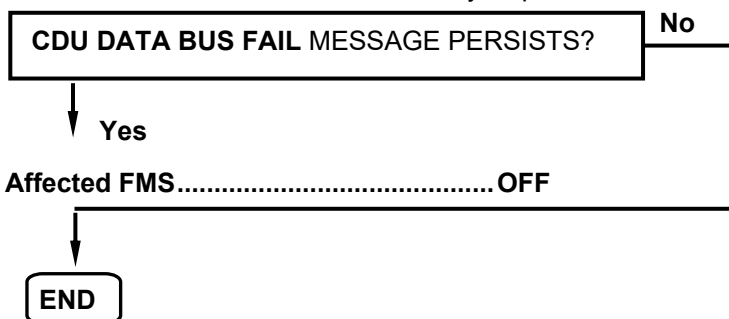

EMERGENCY/PARKING BRAKE HANDLE DISAGREE

Light: BRAKE ON with Emergency/ Parking Brake Handle not actuated.

Do not take off.

END

ENGINE ABNORMAL VIBRATION

EICAS Indication: Engine vibration enters amber range.

Associated Thrust Lever..... REDUCE TO KEEP VIBRATION WITHIN LIMITS

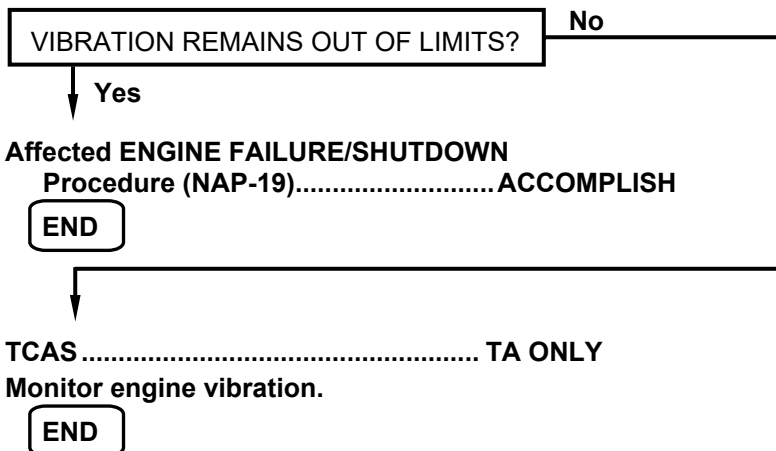

EMERGENCY/ABNORMAL PROCEDURES

Non Annunciated

ENGINE AIRSTART

Inoperative engine:

- Fuel Pump SelectorA or B
- Fuel Pump PwrON
- IgnitionAUTO
- Start/Stop SelectorSTOP
- Engine BleedPUSH OUT
- Thrust LeverIDLE
- Engine Airstart EnvelopeCHECK

ENGINE AIRSTART ENVELOPE

AE3007 ENGINES

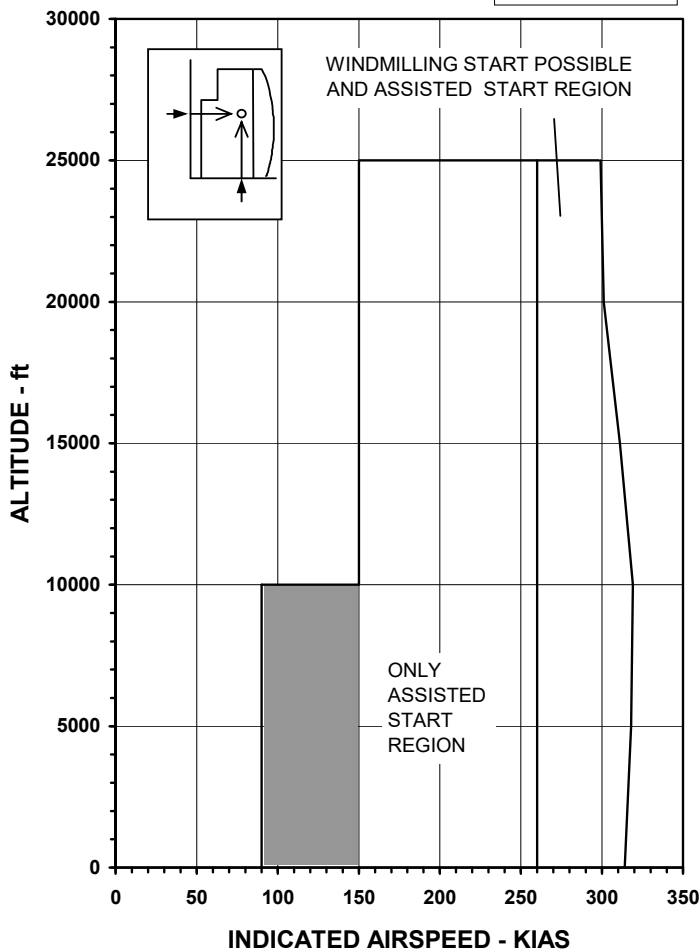

NOTE: Shaded area may be below 1.23 V_{SR}.

CONTINUES ON NEXT PAGE

CONTINUED FROM PREVIOUS PAGE

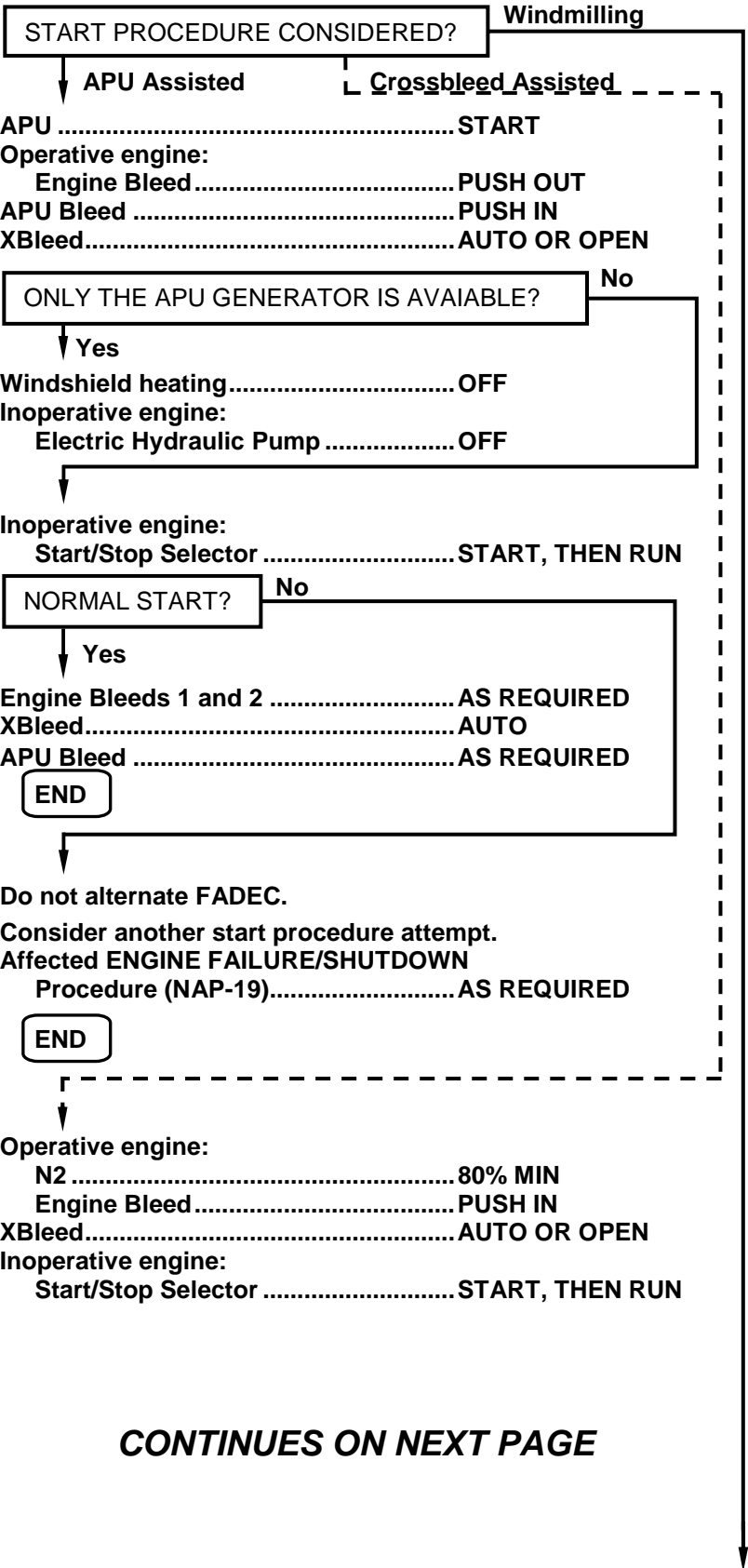

CONTINUES ON NEXT PAGE

EMERGENCY/ABNORMAL PROCEDURES

Non Annunciated

CONTINUED FROM PREVIOUS PAGE

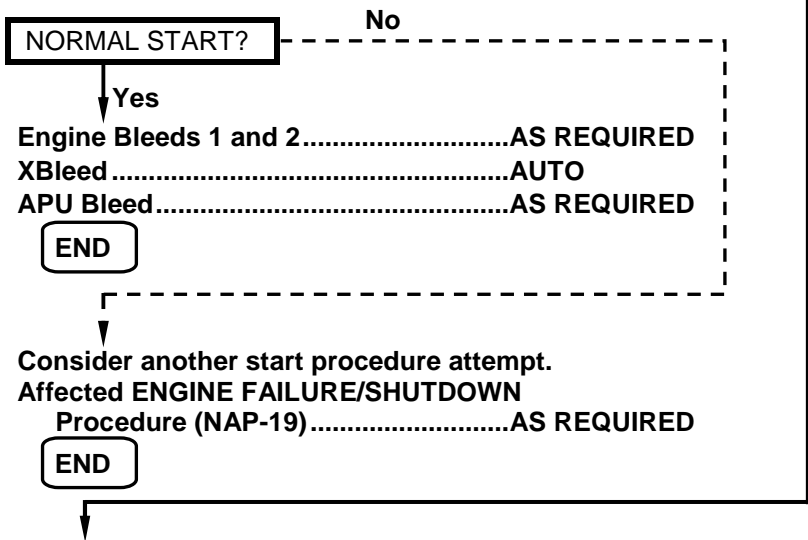

NOTE: Windmilling starts can be attempted in both engines simultaneously.

Airspeed.....MIN 260 KIAS

Inoperative engine:

N2MIN 10%

Initiate windmilling start with N2 as high as possible.
Once N2 is below 10%, it may not be recovered.

Start/Stop Selector.....START, THEN RUN

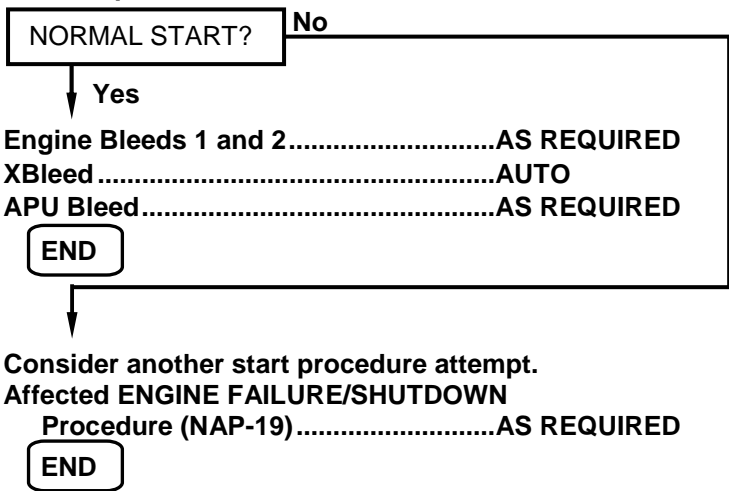

User: aherrera - Printed By myTechCare - Jul 25/22 - 13:50:24

EMERGENCY/ABNORMAL PROCEDURES

Non Annunciated

ENGINE FAILURE/SHUTDOWN

Condition: Loss of thrust on an engine or abnormal engine indication or precautionary shutdown.

Associated Thrust Lever..... IDLE

Associated Start/Stop Selector STOP

NOTE: If engine shutdown does not occur, pull the associated fire extinguishing handle.

Engine Thrust Rating CON

APU (if available) START

APU Bleed AS REQUIRED

XBleed..... AS REQUIRED

Fuel BALANCE

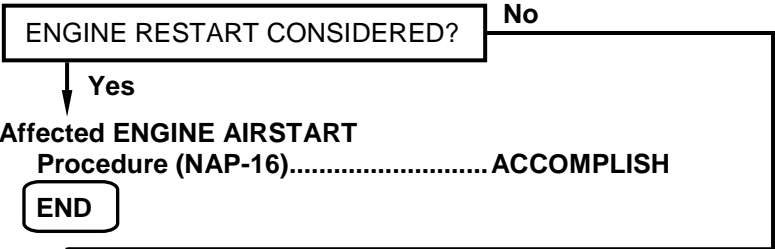

LAND AT THE NEAREST SUITABLE AIRPORT.

TCAS TA ONLY

Altitude MAX 25'000 FT, MIN MEA

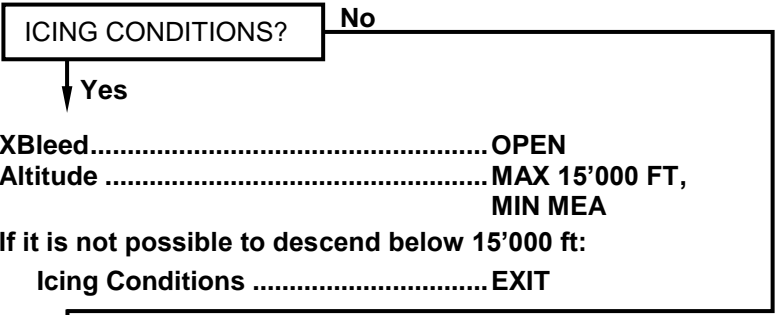

ONE ENGINE INOPERATIVE APPROACH AND LANDING

Procedure (NAP-30)..... AS REQUIRED

END

EMERGENCY/ABNORMAL PROCEDURES

Non Annunciated

ENGINE HIGH OIL PRESSURE

EICAS Indication: Oil pressure pointer in amber range.

OIL TEMPERATURE, OIL LEVEL OR
ENGINE VIBRATION OUT OF LIMITS?

No

Yes

Associated ProcedureACCOMPLISH

END

ENGINE HIGH OIL TEMPERATURE

EICAS Indication: Oil temperature pointer and digits
become red.

Associated Thrust LeverREDUCE

FAILURE PERSISTS?

No

Yes

ABOVE 25'000 FT?

No

Yes

Altitude.....MAX 25'000 FT
MINIMUM MEA

FAILURE PERSISTS?

No

Yes

Affected ENGINE FAILURE/SHUTDOWN
Procedure (NAP-19).....ACCOMPLISH

END

ENGINE LOW OIL LEVEL

MFD Indication: Oil quantity enters amber range.

Affected ENGINE FAILURE/SHUTDOWN

Procedure (NAP-19).....AS REQUIRED

Consider shutting the engine down to preserve oil quantity,
and if required restart it prior to landing.

NOTE: The indication of oil-level is accurate above 3 quarts.

END

ENGINE OIL LOW PRESSURE

EICAS Indication: Oil pressure in amber range.

Associated Thrust LeverREDUCE

Reduce N2 below 88%.

END

NAP-20

REVISION 14

EMERGENCY/ABNORMAL PROCEDURES

Non Annunciated

ENGINE OVERTEMPERATURE

Condition: ITT pointer and digits flashing amber or red.

Associated Thrust Lever..... **REDUCE**

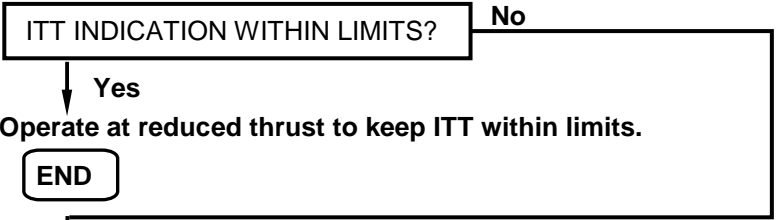

Associated Bleed..... **PUSH OUT**
Altitude **MAX 25'000 FT,**
MIN MEA

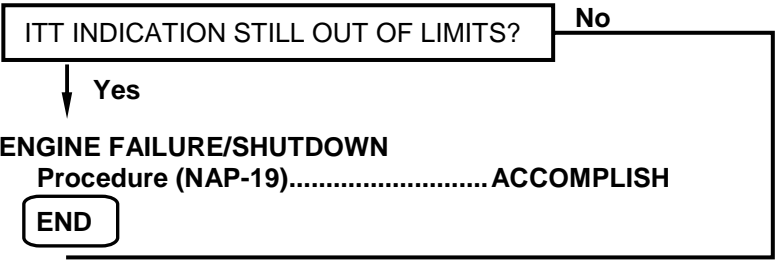

Operate at reduced thrust to keep ITT within limits.
TCAS **TA ONLY**

END

ENGINE TAILPIPE FIRE

Condition: Tailpipe fire was detected visually by crew or ground personnel. No EICAS message displayed.

Affected engine:

- Thrust Lever..... **IDLE**
- Start/Stop Selector **STOP**
- Ignition..... **OFF**
- Fuel Pump **OFF**
- XFeed Selector Knob **OFF**
- Start/Stop Selector **START, THEN RUN**
- ITT **MONITOR**

ATC **NOTIFY**

 **WAIT 90 SECONDS**

Associated Start/Stop Selector **STOP**

Associated

Fire Extinguishing Handle **PULL (DO NOT ROTATE)**

NOTE: If fire is not extinguished while the engine is motored, ground personnel support must be requested.

END

REVISION 14

NAP-21

QRH-145/1115

User: aherrera - Printed By myTechCare - Jul 25/22 - 13:50:24

EMERGENCY/ABNORMAL PROCEDURES

Non Annunciated

ERRONEOUS STALL PROTECTION ACTUATION

Condition: Inadvertent shaker and/or pusher actuation.

Immediately and simultaneously:

- Quick Disconnect ButtonPRESS
- Stall Protection Cutout 1 and 2PUSH OUT
- Minimum AirspeedFLAP
MANEUVERING
SPEED (PD-2)

Avoid skidding the airplane.

To approach and go-around speeds, add 5 KIAS to V_{REF} .

Landing configuration:

- Landing Gear DOWN
- Flaps 45°
- Airspeed $V_{REF 45} + 5$ KIAS

CAUTION: MULTIPLY THE FLAPS 45° UNFACTORED LANDING DISTANCE BY 1.10.

END

GEAR LEVER CANNOT MOVE UP AFTER TAKEOFF

Condition: Landing gear cannot be moved to up position after takeoff in the normal manner.



.....WAIT 10 SECONDS

LG AIR/GND FAIL MESSAGE DISPLAYED?

No

Yes

Landing Gear LeverDO NOT MOVE
LANDING GEAR AIR/GROUND SYSTEM
FAILURE Procedure (EAP 12-6)ACCOMPLISH

END

Downlock Release
Button (DN LOCK REL)PRESS
Landing Gear LeverUP

END

GUST LOCK FAILURE

Light: GUST LOCK (amber).

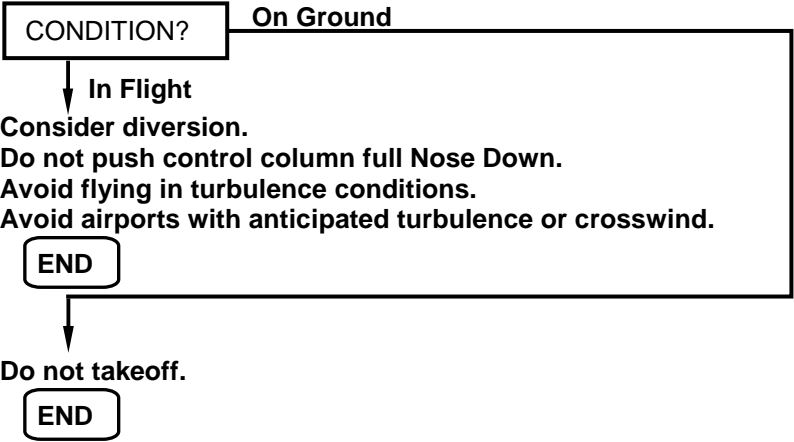

User: aherrera - Printed By myTechCare - Jul 25/22 - 13:50:24

EMERGENCY/ABNORMAL PROCEDURES

Non Annunciated

IMPAIRED OR CRACKED WINDSHIELD

Associated Ice Protection

Windshield.....PUSH OUT

Cockpit Door.....CLOSE

ONLY OUTER LAYER CRACKED?

No

Yes

END

Oxygen Masks.....AS REQUIRED

Smoke Goggle.....DON

Airspeed.....MAX 250 KIAS

Altitude.....MEA OR 10'000 FT,
WHICHEVER IS
HIGHER

Pressurization Manual Controller1 O'CLOCK
POSITION



WAIT 15 SECONDS

Pressurization Mode Selector.....PUSH IN (MAN)

Pressurization Manual ControllerCAB MAX $\Delta P = 1$ PSI

FORWARD VISIBILITY GOOD IN ONE SIDE?

No

Yes

Pilot flying must be on non impaired side.

END

When reaching 10'000 ft:

Pressurization Mode SelectorPUSH OUT

Pressurization Dump ButtonPUSH IN

During approach and landing, when visibility is required:

Airspeed.....MAX 140 KIAS,
MIN V_{REF45}

Check no loose objects in the cockpit.

Direct Vision WindowREMOVE

Landing must be made by looking through Direct Vision Window. Intercommunication will be impossible with window removed.

END

EMERGENCY/ABNORMAL PROCEDURES

Non Annunciated

IRS/MSU FAILURE ANNUNCIATION

LIGHT	OPERATION PHASE		
	POWER ON	ALIGNMENT	IN FLIGHT
ALIGN	<ul style="list-style-type: none"> -No light: -Check IRS CBs. -Set mode select switch to ALIGN or NAV. -Press MSU Test switch. Annunciator bulb must be replaced if the other MSU annunciators do light. 	<p>Accomplish associated IRS ALIGNMENT FAULT Procedure (EAP 2-13)</p>	<ul style="list-style-type: none"> -Flashes: -IRS data is not normal. -Accomplish associated IRS OVERHEAT Procedure (EAP 2-15)
FAULT	<ul style="list-style-type: none"> -Set mode select switch to OFF for at least 3 sec. Then set mode select switch back to ALIGN or NAV. -If the annunciator remains lighted, do not takeoff. 	<ul style="list-style-type: none"> -Associated with ALIGN annunciation: -Check and reenter latitude. -Allow additional time for alignment. -Try new alignment. Set mode select switch to OFF for at least 3 sec, then to ALIGN, and enter present position. -If on ground, do not takeoff. 	<ul style="list-style-type: none"> -Select the remaining IRU by pressing the IRS Button on the associated reversionary panel. -If necessary set mode select switch to ATT.
NO AIR	<ul style="list-style-type: none"> -Do not takeoff. 	<p>*****</p>	<ul style="list-style-type: none"> -Operate IRU until flight completion. -If fault annunciator is ON or inertial data ceases to be transmitted by IRU, accomplish associated IRS OVERHEAT Procedure (EAP 2-15). IRS data is not normal.
BATT FAIL	<ul style="list-style-type: none"> -Do not takeoff. 	<p>*****</p>	<p>*****</p>
ON BATT	<ul style="list-style-type: none"> -Check IRS CBs. -If the annunciator remains lighted, do not takeoff. 	<p>*****</p>	<p>Accomplish associated IRS ON BATTERY Procedure (EAP 2-14).</p>

END

EMERGENCY/ABNORMAL PROCEDURES

Non Annunciated

LOSS OF ENGINE INDICATIONS

Condition: Loss of Thrust Mode, ITT, N1 and N2 indications.

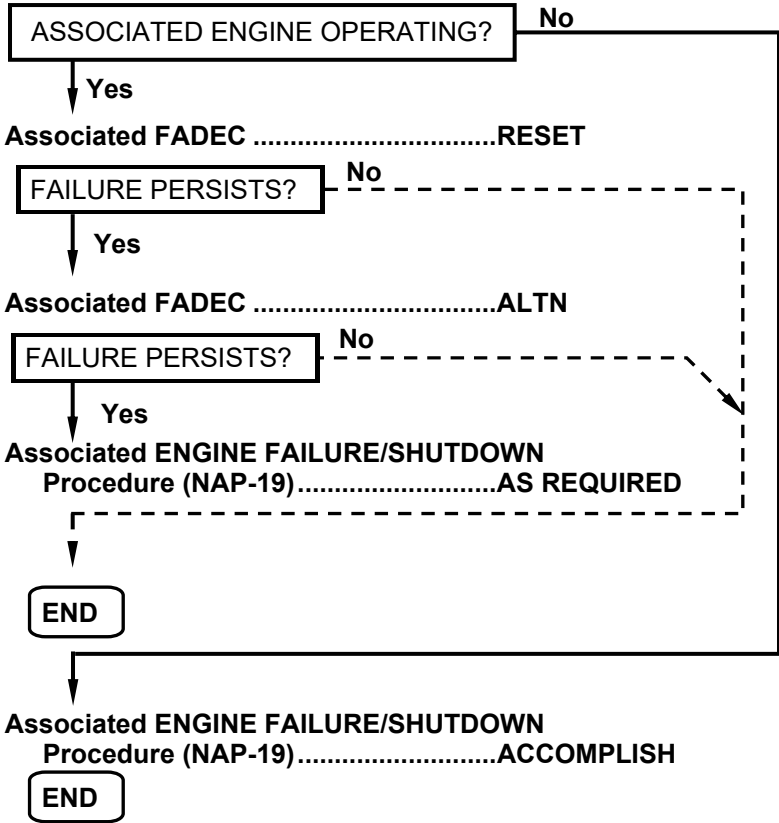

User: aherrera - Printed By myTechCare - Jul 25/22 - 13:50:24

LOSS OF PRESSURIZATION INDICATION

Condition: Cabin altitude or cabin ΔP is not being presented or during use of the pressurization manual control.

Use the remaining indications to maintain cabin altitude below 10'000 ft, according to the table below:

AIRPLANE/CABIN ALTITUDE CONVERSION TABLE

AIRPLANE ALTITUDE (ft)	CABIN ALTITUDE (ft)	DIFFERENTIAL PRESSURE (psi)
10000	300	4.4
11000	500	4.7
12000	700	5.0
13000	900	5.2
14000	1100	5.5
15000	1300	5.7
16000	1500	5.9
17000	1700	6.1
18000	1900	6.3
19000	2200	6.5
20000	2400	6.7
21000	2700	6.8
22000	2900	7.0
23000	3200	7.1
24000	3400	7.2
25000	3800	7.3
26000	4100	7.4
27000	4400	7.5
28000	4700	7.6
29000	5000	7.6
30000	5400	7.7
31000	5700	7.7
32000	6100	7.7
33000	6500	7.7
34000	6800	7.8
35000	7200	7.8
36000	7600	7.8
37000	8000	7.8

If pressurization can not be maintained, refer to PRESSURIZATION AUTOMATIC SYSTEM FAILURE/CABIN DEPRESSURIZATION Procedure (EAP 1-13).

END

EMERGENCY/ABNORMAL PROCEDURES

Non Annunciated

MAIN DOOR BLOCKED

Light: DOOR BLOCKED (Attendant's Panel).

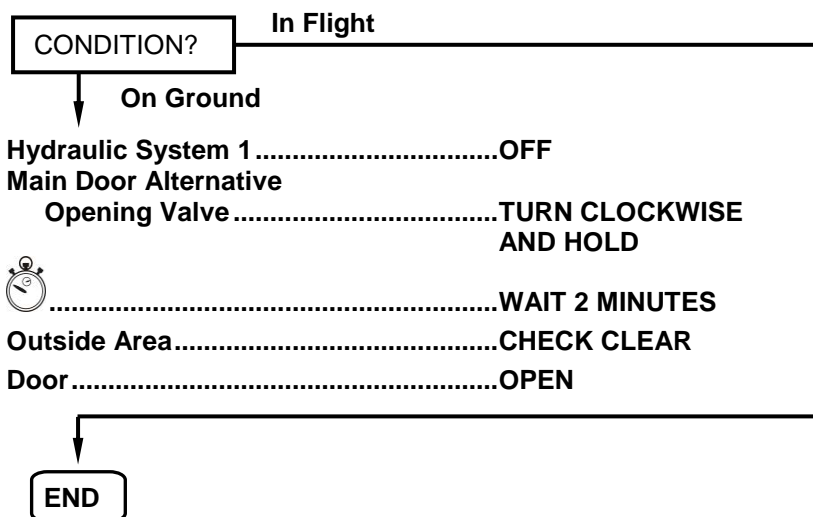

NAV/FLIGHT INSTRUMENTS FAILURE

ANNUNCIATOR/ FAILURE	LOCATION	ACTION
ATT: CAGE (amber)	ISIS	Press the CAGE push button in order to recover attitude indication. Caging the ISIS in flight will result in loss of attitude indication for up to 10 seconds and the amber message ATT 10s will be presented during this time. Use the primary indication source until attitude indication is available.
ATT, ALT, SPD, M, HDG (red)		Use the primary indication source. If on ground, do not takeoff.
MENU INOP (amber)	MFD	Do not takeoff.
HDG FAIL (red)	PFD MFD	Use cross-side heading by pressing the AHRS (IRS) button on associated reversionary panel or use RMU or standby attitude indicator.

CONTINUES ON NEXT PAGE

EMERGENCY/ABNORMAL PROCEDURES

Non Annunciated

CONTINUED FROM PREVIOUS PAGE

ANNUNCIATOR/ FAILURE	LOCATION	ACTION
HDG (amber)	PFD MFD	Identify the failed side by comparing data with the Magnetic Compass and use cross-side data by pressing the AHRS (IRS) on associated reversionary panel.
ALT, ATT, IAS, PIT or ROL (amber)		Compare data with Standby Indicator. For altitude, compare the PFD altimeters setting also. If required, use cross-side data by pressing the appropriate button on associated reversionary panel.
ATT FAIL (red)		Push in the AHRS (IRS) button on associated reversionary panel or use standby attitude indicator.
RA (amber)	PFD	Compare both radio altimeter indications. If required, consider only the lower indication. Otherwise, disregard Radio Altitude. If RA is displayed in the center, the RA is failed.
RA1 (2) (amber)		Radio altimeter automatic reversion has occurred. No action is required.
VS (red)		Push in the ADC button on associated reversionary panel.
"X" (red) over IAS tape and/or altitude tape		Push in the ADC button on associated reversionary panel or use standby indications.
"X" (red) over course scale		Select another sensor.
Blank or "X" (red) on PFD or EICAS		Use the MFD Knob to present the required information on MFD.
Errors in attitude indication	Standby Attitude Instrument	Maintain a straight and leveled flight using the primary indication source. Wait 3 minutes. If error persists, cage the instrument and wait 5 min.

END

EMERGENCY/ABNORMAL PROCEDURES

Non Annunciated

NOSE LANDING GEAR UP DOOR OPEN

Condition: Noise increase due to nose landing gear doors open.

Airspeed.....MAX 250 KIAS

Icing Conditions.....AVOID/EXIT

Fuel ConsumptionMONITOR

ABNORMAL LANDING GEAR EXTENSION

Procedure (NAP-13).....AS REQUIRED

END

ONE ENGINE INOPERATIVE APPROACH AND LANDING

For CAT III mode or CAT II approaches using HGS, the normal CAT III approach procedure must be used.

Approach:

AltimetersSET AND CROSS CHECKED

Approach AidsSET AND CROSS CHECKED

Speed BugsSET

PressurizationCHECK

Go-Around ProcedureREVIEW

- Disengage Autopilot.
- Press Go-Around Button.
- Advance Operative Engine Thrust Lever to MAX.
- Rotate airplane to 10° nose up.
- Set flaps to 9°.

With positive rate of climb:

- Landing gear up.
- Maintain Approach Climb Speed until reaching acceleration altitude (level off).

Before Landing:

Inoperative Engine

Thrust LeverIDLE

Landing GearDOWN

Thrust RatingTAKEOFF MODE

Fuel XFeedOFF

Autopilot/Yaw DamperDISENGAGE

Landing configuration:

Flaps.....22°

V_{REF}V_{REF45} + 10 KIAS

CAUTION: MULTIPLY THE FLAPS 45° UNFACTORED LANDING DISTANCE BY 1.48.

END

OVERWEIGHT LANDING

Before touchdown:

- Emerg Lts AS REQUIRED
- APU Fuel Shutoff Button PUSH IN
- Rate of Descent MAX 300 FT/MIN

Touch smoothly the runway surface.

Reduce the engine thrust only after the touchdown.

Landing configuration:

- Flaps 45°
- V_{REF} V_{REF45}

CAUTION: MULTIPLY THE FLAPS 45° UNFACTORED LANDING DISTANCE BY AT LEAST 1.10.

END

OXYGEN LEAKAGE

Condition: Evidence of oxygen leakage through the crew mask, mask hose, flow indicator (blinker), or oxygen line.

No Smoking ON

IS THE LEAKAGE IN THE CREW MASK, MASK HOSE, OR FLOW INDICATOR?

No

Yes

- Affected Mask REMOVE FROM STORAGE BOX
- Stowage Box Doors CLOSE
- Shutoff Sliding Control ACTUATE
- Oxygen Pressure CHECK

OXYGEN PRESSURE BELOW MINIMUM REQUIRED FOR DISPATCH?

No

Yes

- Altitude MEA OR 10'000 FT, WHICHEVER IS HIGHER

END

Keep one Portable Oxygen Cylinder available for the pilot of the affected side. The oxygen supply by the Portable Oxygen Cylinder will last at least 30 minutes.

END

- Oxygen Cylinder Shutoff Valve OFF
- Altitude MEA OR 10'000 FT, WHICHEVER IS HIGHER

END

User: aherrera - Printed By myTechCare - Jul 25/22 - 13:50:24

EMERGENCY/ABNORMAL PROCEDURES

Non Annunciated

PARTIAL OR GEAR UP LANDING

Condition: Airplane committed to land with gear up or in transit.

EICAS Indication: Abnormal landing gear position.

EICAS Warning: LG/LEVER DISAGREE may be presented.

ATC.....**NOTIFY**

Burn fuel to reduce touchdown speed.

Transponder**7700**

FSTN Belts**ON**

Cabin Crew**NOTIFY**

Passengers (and Crew)**PREPARE FOR EMERGENCY LANDING AND EVACUATION**

Below 10'000 ft:

GPWS CB (J7 or J8).....**PULL**

Aural Warn CBs (B4 and E30).....**PULL**

Emerg Lts**ON**

ELT**ON**

Prior to approach:

Hydraulic Elec Pumps 1 and 2**OFF**

Cabin**DEPRESSURIZE**

Engine Bleeds 1 and 2.....**PUSH OUT**

When committed to land:

Landing Gear.....**AS REQUIRED**

The decision to land with all gear up or with any gear extended is left to pilots. Ground spoilers and thrust reversers will not operate if any main gear is up.

Flaps.....**45°**

If it is not possible to achieve the selected flap position, maintain airspeed according to the following:

FLAPS POSITION	MIN AIRSPEED
0 to 8°	$V_{REF45} + 30$ KIAS
9° to 21°	$V_{REF45} + 10$ KIAS
22° to 44°	$V_{REF45} + 5$ KIAS
45°	V_{REF45}

Just before touchdown:

Cabin **ANNOUNCE IMPACT**

Apply thrust reverser (if available) after touchdown.

When the airplane stops:

Fire Extinguishing Handles**PULL**

APU Fuel Shutoff Button.....**PUSH IN**

Engines and APU Fire Extinguishing

Bottles (if necessary)**DISCHARGE**

Fuel Pumps Pwr 1 and 2**OFF**

EMERGENCY EVACUATION

Procedure**ACCOMPLISH**

Before leaving the airplane:

Batteries 1 and 2**OFF**

END

NAP-32

REVISION 17

Copyright © by Embraer. Refer to cover page for details.

QRH-145/1115

RUDDER ARTIFICIAL FEEL INOPERATIVE

Condition: Rudder pedals become light and do not center by themselves. Yaw trim does not operate properly.

Rudder Shutoff Sys 2 PUSH OUT

FAILURE PERSISTS? No

Yes

Rudder Shutoff Sys 1 PUSH OUT

Expect greater rudder pedal force. If required, both pilots should act together to control the airplane.

Consider the use of aileron to help in yaw control, and asymmetric thrust to trim the airplane.

Avoid airports with anticipated turbulence or crosswind.

END

RUDDER/YAW TRIM RUNAWAY

Condition: Sudden uncommanded yaw.

EICAS Indication: Associated yaw trim indication changes.

Quick Disconnect Button PRESS AND HOLD
Rudder Shutoff Sys 1 and 2 PUSH OUT

Airspeed MAX 250 KIAS

Yaw Trim Position CHECK

YAW TRIM DISPLACED FROM NEUTRAL? No

Yes

Yaw Trim CB (F12) PULL

Quick Disconnect Button RELEASE

Rudder Shutoff Sys 1 and 2 PUSH IN

END

Quick Disconnect Button RELEASE

Prepare to overcome uncommanded yaw.

Rudder Shutoff Sys 1 PUSH IN

CONTINUES ON NEXT PAGE

User: aherrera - Printed By myTechCare - Jul 25/22 - 13:50:24

EMERGENCY/ABNORMAL PROCEDURES

Non Annunciated

CONTINUED FROM PREVIOUS PAGE

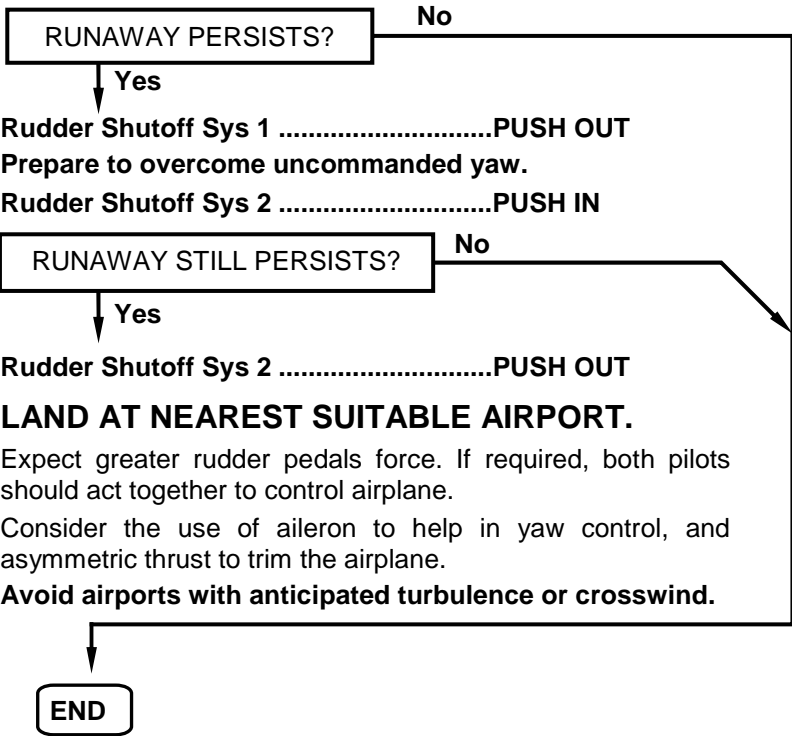

SINGLE ENGINE BLEED OPERATION IN ICING CONDITIONS

XBleed OPEN
Altitude MAX 15'000 FT,
MIN MEA
If it is not possible to descend below 15'000 ft:
Icing Conditions EXIT

END

User: aherrera - Printed By myTechCare - Jul 25/22 - 13:50:24

EMERGENCY/ABNORMAL PROCEDURES

Non Annunciated

STIFFENED ELEVATOR

Condition: Elevator control columns movement is stiffened.

EICAS Warning: AUTOPILOT FAIL (may be presented),
SPS 1-2 INOP (may be presented)

EICAS Caution: STICK PUSHER FAIL (may be presented)

Autopilot **DISENGAGE**

Pitch Trim **AS REQUIRED**

Avoid abrupt and large elevator inputs.

Consider descent to a warmer altitude.

Freezing conditions may lead to de/anti-icing fluids residues to stiffen the elevator.

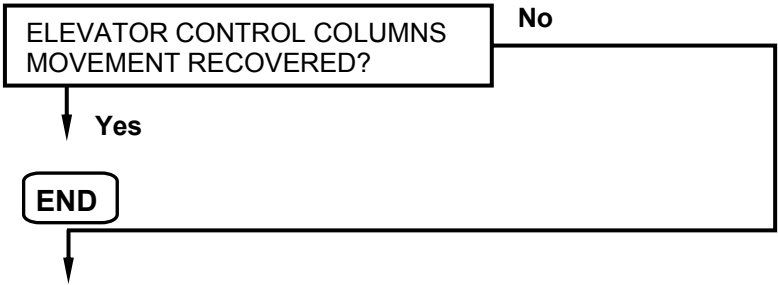

JAMMED ELEVATOR

Procedure (NAP-8)..... **ACCOMPLISH**

END

User: aherrera - Printed By myTechCare - Jul 25/22 - 13:50:24

EMERGENCY/ABNORMAL PROCEDURES

Non Annunciated

STRUCTURAL DAMAGE

Land at the nearest suitable airport.

At safe altitude, evaluate airplane aero dynamical behavior and take extra caution varying airspeed and attitude.

Use the flight controls with caution avoiding high maneuvering loads.

FUSELAGE DAMAGED OR
SUSPECTED DAMAGED?

No

Yes

Oxygen Masks AS REQUIRED
Altitude MEA OR 10'000 FT,
WHICHEVER IS
HIGHER

When reaching 10'000 ft:

Pressurization Dump Button PUSH IN

Land as smooth as possible.

END

TRANSPONDER FAIL

Condition: The transponder mode annunciation is replaced with dashes on the RMU Radio page or by ATC notification.

TRANSPONDER SELECT ANOTHER

END

UNCOMMANDED ELEVATOR OR AILERON DISCONNECTION

Light: Amber ELEV DISC or AIL DISC on Pedestal.

Condition: One control column or control wheel moves independently of the other.

Affected Surface Disconnection

Handle PULL

If aileron is affected, aileron artificial feel not available on left side.

Avoid airports with anticipated turbulence or crosswind.

END

UNRELIABLE AIRSPEED

Autopilot/Yaw Damper DISENGAGE

Both Flight Directors OFF

SPEED INDICATION ON BOTH PFDS BELOW 135 KIAS? **No**

↓ **Yes**

Rudder Shutoff Sys 1 PUSH OUT

CAUTION: AVOID USING THE SPEEDBRAKE.

Attitude/Thrust ADJUST

Maintain airplane control. Refer to Unreliable Airspeed tables in the Performance Data section. Altitude and/or Vertical Speed indications may also be unreliable.

Ground speed indication is available in the FMS for reference.

END

User: aherrera - Printed By myTechCare - Jul 25/22 - 13:50:24

EMERGENCY/ABNORMAL PROCEDURES

Non Annunciated

VOLCANIC ASH

LAND AT THE NEAREST SUITABLE AIRPORT.

Volcanic Ash Area..... EXIT/AVOID

Consider performing a 180° turn.

Oxygen Masks (if necessary)..... DON, 100%

If a significant amount of volcanic ash fills the cockpit or if there is a strong smell of sulphur, don an oxygen mask and select 100%.

APU..... START

Ignitions ON

Thrust Levers (if altitude permits)..... IDLE

Anti-Icing Buttons (Engine, Wing and Stabilizer) CHECK PUSHED IN

Ice Detection Override Knob..... ALL

ITT MONITOR

ITT INCREASES?

No

Yes

Affected Engine..... SHUT DOWN

After affected engine has cooled down:

Affected Engine..... RESTART

If the affected engine fails to restart, repeated attempts should be made immediately.

Airspeed..... MONITOR

ABNORMAL AIRSPEED INDICATIONS?

No

Yes

UNRELIABLE AIRSPEED

Procedure (NAP-37)..... ACCOMPLISH

Restore systems to normal operation.

ATC..... NOTIFY

END

User: aherrera - Printed By myTechCare - Jul 25/22 - 13:50:24

EMERGENCY/ABNORMAL PROCEDURES

Index

INDEX BY EICAS MESSAGE

TYPE	MESSAGE	PAGE OR INSTRUCTION
W A R N I N G	APU FIRE	EAP 3-3
	ATTCS FAIL	EAP 6-3
	AUTOPILOT FAIL	EAP 2-3
	BAGG SMOKE	S-3
	BATT 1 OVTEMP	EAP 5-3
	BATT 2 OVTEMP	EAP 5-3
	BLD 1 LEAK	EAP 1-4
	BLD 1 OVTEMP	EAP 1-5
	BLD 2 LEAK	EAP 1-4
	BLD 2 OVTEMP	EAP 1-5
	BLD APU LEAK	EAP 1-3
	E1 ATTCS NO MRGN	EAP 6-5
	E1 LOW N1	Crew Awareness
	E1 OIL LOW PRESS	EAP 6-7
	E2 ATTCS NO MRGN	EAP 6-5
	E2 LOW N1	Crew Awareness
	E2 OIL LOW PRESS	EAP 6-7
	ELEC ESS XFR FAIL	EAP 5-3
	ENG 1 FIRE	EAP 6-6
	ENG 2 FIRE	EAP 6-6
	ENG 1-2 OUT	EAP 6-3
	FUEL 1 LO LEVEL	EAP 9-3
	FUEL 2 LO LEVEL	EAP 9-3
	GPWS	Crew Awareness
	ICE COND-A/I INOP	EAP 11-3
	LAV SMOKE	S-3
	LG/LEVER DISAGREE	EAP 12-3
	MAIN DOOR OPN	EAP 4-3
	NO TAKEOFF CONFIG	EAP 14-4
	PIT TRIM 1 INOP	EAP 8-4
	PIT TRIM 2 INOP	EAP 8-4
	PTRIM BACKUP INOP	EAP 8-4
	PTRIM MAIN INOP	EAP 8-4
	SERVICE DOOR OPN	EAP 4-3
	SPS 1 INOP	EAP 14-3
	SPS 1-2 INOP	EAP 14-4
	SPS 2 INOP	EAP 14-3

User: aherrera - Printed By myTechCare - Jul 25/22 - 13:50:24

EMERGENCY/ABNORMAL PROCEDURES

Index

TYPE	MESSAGE	PAGE OR INSTRUCTION
C A U T I O N	115 VAC BUS OFF	EAP 5-5
	A/ICE LOW CAPACIT	EAP 11-4
	A/ICE SWITCH OFF	EAP 11-4
	ACCESS DOORS OPN	EAP 4-4
	AHRS 1 ALN FAULT	EAP 2-3
	AHRS 1 FAIL	EAP 2-4
	AHRS 1 OVERHEAT	EAP 2-4
	AHRS 2 ALN FAULT	EAP 2-3
	AHRS 2 FAIL	EAP 2-4
	AHRS 2 OVERHEAT	EAP 2-4
	AIL SYS 1 INOP	EAP 8-6
	AIL SYS 1-2 INOP	EAP 10-3
	AIL SYS 2 INOP	EAP 8-6
	AOA 1 HEAT INOP	EAP 11-4
	AOA 2 HEAT INOP	EAP 11-4
	AP AIL MISTRIM	EAP 2-5
	AP ELEV MISTRIM	EAP 2-5
	APU BLD VLV FAIL	EAP 1-5
	APU CNTOR CLSD	EAP 3-4
	APU EXTBTL INOP	EAP 7-3
	APU FAIL	EAP 3-4
	APU FIREDET FAIL	EAP 7-3
	APU FUEL LO PRESS	EAP 3-4
	APU FUEL SOV INOP	EAP 9-4
	APU GEN OFF BUS	EAP 5-12
	APU GEN OVLD	EAP 5-12
	APU OIL HI TEMP	EAP 3-5
	APU OIL LO PRESS	EAP 3-5
	AURAL WARN FAIL	EAP 14-6
	AUTO TRIM FAIL	EAP 2-6
	BAGG EXTBTL INOP	EAP 7-4
	BAGGAGE DOOR OPN	EAP 4-4
	BATT1 OFF BUS	EAP 5-5
	BATT2 OFF BUS	EAP 5-5
	BKUP BATT OFF BUS	EAP 5-5
	BLD 1 LOW TEMP	EAP 1-6
	BLD 1 VLV FAIL	EAP 1-7
	BLD 2 LOW TEMP	EAP 1-6
	BLD 2 VLV FAIL	EAP 1-7
	BRAKE DEGRADED	EAP 12-5
	BRAKE OVERHEAT	EAP 12-4
	BRK INBD INOP	EAP 12-5
	BRK OUTBD INOP	EAP 12-5
	CHECK IC 1 SW	Crew Awareness
	CHECK IC 2 SW	Crew Awareness
	CHECK PFD 1	EAP 2-8
	CHECK PFD 2	EAP 2-8
	CHECK XPDR	Crew Awareness

EAP 0-2

REVISION 19

Copyright © by Embraer. Refer to cover page for details.

QRH-145/1115

User: aherrera - Printed By myTechCare - Jul 25/22 - 13:50:24

EMERGENCY/ABNORMAL PROCEDURES

Index

TYPE	MESSAGE	PAGE OR INSTRUCTION
C A U T I O N	CHK IC CONFIG	Crew Awareness
	CROSS BLD FAIL	EAP 1-8
	CROSS BLD SW OFF	Crew Awareness
	CREW OXYGEN LO PRESS	EAP 13-3
	DAU AC ID MISCMP	Crew Awareness
	DAU1 A FAIL	EAP 2-6
	DAU1 ENG MISCOMP	EAP 2-7
	DAU1 SYS MISCOMP	EAP 2-7
	DAU1 WRN MISCOMP	EAP 2-7
	DAU2 A FAIL	EAP 2-6
	DAU2 ENG MISCOMP	EAP 2-7
	DAU2 SYS MISCOMP	EAP 2-7
	DAU2 WRN MISCOMP	EAP 2-7
	DC BUS 1 OFF	EAP 5-6
	DC BUS 2 OFF	EAP 5-7
	DEFUEL NOT CLOSED	EAP 9-4
	DFDR FAIL	Crew Awareness
	E1 A/ICE FAIL	EAP 11-5
	E1 ATS SOV OPN	EAP 6-8
	E1 CTL FAIL	EAP 6-9
	E1 EXCEEDANCE	Crew Awareness
	E1 EXTBTLA INOP	EAP 7-5
	E1 EXTBTLB INOP	EAP 7-5
	E1 FIREDET FAIL	EAP 7-4
	E1 FPMU NO DISP	Crew Awareness
	E1 FUEL LO PRESS	EAP 9-5
	E1 FUEL LO TEMP	EAP 9-5
	E1 FUEL SOV INOP	EAP 9-6
	E1 NO DISP	Crew Awareness
	E2 A/ICE FAIL	EAP 11-5
	E2 ATS SOV OPN	EAP 6-8
	E2 CTL FAIL	EAP 6-9
	E2 EXCEEDANCE	Crew Awareness
	E2 EXTBTLA INOP	EAP 7-5
	E2 EXTBTLB INOP	EAP 7-5
	E2 FIREDET FAIL	EAP 7-4
	E2 FPMU NO DISP	Crew Awareness
	E2 FUEL LO PRESS	EAP 9-5
	E2 FUEL LO TEMP	EAP 9-5
	E2 FUEL SOV INOP	EAP 9-6
	E2 NO DISP	Crew Awareness
	ELEC EMERG ABNORM	EAP 5-8
	ELEKBAY OVTEMP	EAP 2-9
	EMERG EXIT OPN	EAP 4-5
	EMERG LT NOT ARMD	EAP 5-8
EMRG BRK LO PRES	EAP 12-5	
ENG1 REV DISAGREE	EAP 6-12	
ENG1 REV FAIL	EAP 6-12	

User: aherrera - Printed By myTechCare - Jul 25/22 - 13:50:24

QRH-145/1115

EMERGENCY/ABNORMAL PROCEDURES

Index

TYPE	MESSAGE	PAGE OR INSTRUCTION
C A U T I O N	ENG2 REV DISAGREE	EAP 6-12
	ENG2 REV FAIL	EAP 6-12
	ENG NO TO DATA	Crew Awareness
	ENG REF A/I DISAG	Crew Awareness
	ENG1 OUT	EAP 6-10
	ENG1 TLA FAIL	EAP 6-11
	ENG2 OUT	EAP 6-10
	ENG2 TLA FAIL	EAP 6-11
	ESS BUS 1 OFF	EAP 5-9
	ESS BUS 1-2 OFF	EAP 5-11
	ESS BUS 2 OFF	EAP 5-10
	FADEC ID NO DISP	Crew Awareness
	FLAP FAIL	EAP 8-7
	FUEL XFEED FAIL	EAP 9-6
	FUELING DOOR OPN	Crew Awareness
	FUEL EQ XFEED OPN	EAP 9-6
	FUEL IMBALANCE	EAP 9-7
	FUEL TANK LO TEMP	EAP 9-7
	GEN 1-2-3-4 OFF BUS APU GEN OFF BUS	EAP 5-4
	GEN 1 OFF BUS	EAP 5-12
	GEN 1 OVLD	EAP 5-12
	GEN 2 OFF BUS	EAP 5-12
	GEN 2 OVLD	EAP 5-12
	GEN 3 OFF BUS	EAP 5-12
	GEN 3 OVLD	EAP 5-12
	GEN 4 OFF BUS	EAP 5-12
	GEN 4 OVLD	EAP 5-12
	GPWS INOP	EAP 14-6
	HGS FAIL	Crew Awareness
	HS VLV 1 FAIL	EAP 1-8
	HS VLV 2 FAIL	EAP 1-8
	HYD SYS 1 FAIL	EAP 10-5
	HYD SYS 1 OVHT	EAP 10-7
	HYD SYS 1-2 FAIL	EAP 10-3
	HYD SYS 2 FAIL	EAP 10-6
	HYD SYS 2 OVHT	EAP 10-7
	IC 1 OVERHEAT	EAP 2-12
	IC 1 WOW INOP	Crew Awareness
	IC 2 OVERHEAT	EAP 2-12
	IC 2 WOW INOP	Crew Awareness
	IC BUS FAIL	EAP 2-11
	ICE DET1 FAIL	EAP 11-5
	ICE DET2 FAIL	EAP 11-5
	ICE DETECTORS FAIL	EAP 11-5
	IRS 1 ALN FAULT	EAP 2-12
	IRS 1 FAIL	EAP 2-14
	IRS 1 OVERHEAT	EAP 2-15

EMERGENCY/ABNORMAL PROCEDURES

Index

TYPE	MESSAGE	PAGE OR INSTRUCTION
	IRS 2 ALN FAULT	EAP 2-12
	IRS 2 FAIL	EAP 2-14
	IRS 2 OVERHEAT	EAP 2-15
	LATERAL MODE OFF	EAP 2-11
	LG AIR/GND FAIL	EAP 12-6
	NLG UP/DOOR OPN	EAP 12-3
	NO ICE-A/ICE ON	EAP 11-6
	OXYGEN LO PRESS	EAP 13-3
	PACK 1 OVHT	EAP 1-9
	PACK 1 OVLD	EAP 1-10
	PACK 1 VLV FAIL	EAP 1-12
	PACK 2 OVHT	EAP 1-9
	PACK 2 OVLD	EAP 1-10
	PACK 2 VLV FAIL	EAP 1-12
	PAX OXYGEN LO PRESS	EAP 13-3
	PITOT 1 INOP	EAP 11-6
	PITOT 2 INOP	EAP 11-6
	PITOT 3 INOP	EAP 11-6
	PRESN AUTO FAIL	EAP 1-13
	PTRIM BKP SW FAIL	EAP 8-8
	PTRIM CPT SW FAIL	EAP 8-8
	PTRIM F/O SW FAIL	EAP 8-8
	RAM AIR VLV FAIL	EAP 1-14
	RUD HDOV PROTFAIL	EAP 8-8
	RUDDER OVERBOOST	EAP 8-9
	RUDDER SYS 1 INOP	EAP 8-10
	RUDDER SYS 1-2 INOP	EAP 8-10
	RUDDER SYS 2 INOP	EAP 8-10
	SHED BUS 1 OFF	Crew Awareness
	SHED BUS 2 OFF	Crew Awareness
	SPBK LVR DISAGREE	EAP 8-10
	SPOILER FAIL	EAP 8-3
	SPS ADVANCED	EAP 14-5
STAB A/ICE FAIL	EAP 11-8	
STEER INOP	EAP 12-7	
STICK PUSHER FAIL	EAP 14-4	
TAT 1 HEAT INOP	EAP 11-7	
TAT 2 HEAT INOP	EAP 11-7	
TERR INOP	EAP 14-6	
VERTICAL MODE OFF	EAP 2-11	
W/S 1 HEAT FAIL	EAP 11-7	
W/S 2 HEAT FAIL	EAP 11-7	
WG A/ICE FAIL	EAP 11-8	
WINDSHEAR INOP	EAP 14-6	
YAW DAMPER FAIL	EAP 2-16	

CAUTION

User: aherrera - Printed By myTechCare - Jul 25/22 - 13:50:24

EMERGENCY/ABNORMAL PROCEDURES

Index

TYPE	MESSAGE	PAGE OR INSTRUCTION
A D V I S O R Y	AHRS 1 ALN	Crew Awareness
	AHRS 1 ATT MODE	EAP 2-3
	AHRS 1 BASIC MODE	Crew Awareness
	AHRS 1 EXC MOTION	Crew Awareness
	AHRS 1 NO MAG HDG	Crew Awareness
	AHRS 1 NO PPOS	Crew Awareness
	AHRS 1 ON BATT	EAP 2-4
	AHRS 2 ALN	Crew Awareness
	AHRS 2 ATT MODE	EAP 2-3
	AHRS 2 BASIC MODE	Crew Awareness
	AHRS 2 EXC MOTION	Crew Awareness
	AHRS 2 NO MAG HDG	Crew Awareness
	AHRS 2 NO PPOS	Crew Awareness
	AHRS 2 ON BATT	EAP 2-4
	AIII NOT AVAIL	Crew Awareness
	APU FUEL SOV CLSD	Crew Awareness
	BLD 1 VLV CLSD	EAP 1-7
	BLD 2 VLV CLSD	EAP 1-7
	CHECK A PERF	Crew Awareness
	CHECK A1 PERF	Crew Awareness
	CHECK A1/3 PERF	Crew Awareness
	CHECK A1P PERF	Crew Awareness
	CHECK A3 PERF	Crew Awareness
	CMC FAIL	Crew Awareness
	CONFIG MISMATCH	Crew Awareness
	CROSS BLD OPEN	Crew Awareness
	DAU1 B FAIL	Crew Awareness
	DAU 1 REVERSION	Crew Awareness
	DAU2 B FAIL	Crew Awareness
	DAU 2 REVERSION	Crew Awareness
	DU 1 FAN FAIL	Crew Awareness
	DU 1 OVHT	Crew Awareness
	DU 2 FAN FAIL	Crew Awareness
	DU 2 OVHT	Crew Awareness
	DU 3 FAN FAIL	Crew Awareness
	DU 3 OVHT	Crew Awareness
	DU 4 FAN FAIL	Crew Awareness
	DU 4 OVHT	Crew Awareness
	DU 5 FAN FAIL	Crew Awareness
	DU 5 OVHT	Crew Awareness
	E1 FUEL IMP BYP	EAP 6-9
	E1 FUEL SOV CLSD	Crew Awareness
	E1 HYD PUMP FAIL	Crew Awareness
	E1 HYD SOV CLSD	Crew Awareness

EMERGENCY/ABNORMAL PROCEDURES

Index

TYPE	MESSAGE	PAGE OR INSTRUCTION
A D V I S O R Y	E1 IDL STP FAIL	EAP 6-9
	E1 OIL IMP BYP	Crew Awareness
	E1 SHORT DISP	Crew Awareness
	E1-2 FUEL IMP BYP	EAP 6-9
	E1-2 HYD PUMP FAIL	Crew Awareness
	E2 FUEL IMP BYP	EAP 6-9
	E2 FUEL SOV CLSD	Crew Awareness
	E2 HYD PUMP FAIL	Crew Awareness
	E2 HYD SOV CLSD	Crew Awareness
	E2 IDL STP FAIL	EAP 6-9
	E2 OIL IMP BYP	Crew Awareness
	E2 SHORT DISP	Crew Awareness
	ENG A/ICE OVERPRES	Crew Awareness
	FDAU FAIL	Crew Awareness
	FLAP LOW SPEED	EAP 8-8
	FUEL XFEED OPEN	Crew Awareness
	GEN1 BRG FAIL	Crew Awareness
	GEN2 BRG FAIL	Crew Awareness
	GEN3 BRG FAIL	Crew Awareness
	GEN4 BRG FAIL	Crew Awareness
	HYD PUMP SELEC OFF	Crew Awareness
	HYD1 LO QTY	EAP 10-7
	HYD2 LO QTY	EAP 10-7
	IC1 CONFIG FAIL	Crew Awareness
	IC 1 FAN FAIL	Crew Awareness
	IC2 CONFIG FAIL	Crew Awareness
	IC 2 FAN FAIL	Crew Awareness
	ICE CONDITION	Crew Awareness
	IRS 1 ALN	EAP 2-12
	IRS 1 ATT MODE	EAP 2-13
	IRS 1 EXC MOTION	Crew Awareness
	IRS 1 NO MAG HDG	Crew Awareness
	IRS 1 NO PPOS	Crew Awareness
	IRS 1 ON BATT	EAP 2-14
	IRS 2 ALN	EAP 2-12
	IRS 2 ATT MODE	EAP 2-13
	IRS 2 EXC MOTION	Crew Awareness
	IRS 2 NO MAG HDG	Crew Awareness
	IRS 2 NO PPOS	Crew Awareness
	IRS 2 ON BATT	EAP 2-14
	PACK 1 VLV CLSD	EAP 1-11
	PACK 2 VLV CLSD	EAP 1-11
	RAD ALT 1 FAIL	EAP 2-16
	RAD ALT 2 FAIL	EAP 2-16
	RAD ALT FAIL	EAP 2-16
SPS/ICE SPEEDS	Crew Awareness	

User: aherrera - Printed By myTechCare - Jul 25/22 - 13:50:24

QRH-145/1115

REVISION 16

EAP 0-7

Copyright © by Embraer. Refer to cover page for details.

EMERGENCY/ABNORMAL PROCEDURES

Index

INTENTIONALLY BLANK

EMERGENCY/ABNORMAL PROCEDURES

Air Conditioning, Pneumatics & Pressurization

TABLE OF CONTENTS ANNUNCIATED PROCEDURES

BLEED APU LEAK	EAP 1-3
BLEED ENGINE LEAK.....	EAP 1-4
BLEED OVERTEMPERATURE	EAP 1-5
SMOKE / FIRE / FUMES.....	refer to S-6
APU BLEED VALVE FAILURE	EAP 1-5
BLEED LOW TEMPERATURE	EAP 1-6
BLEED VALVE CLOSED	EAP 1-7
BLEED VALVE FAILURE.....	EAP 1-7
CABIN DEPRESSURIZATION.....	EAP 1-13
CABIN RATE ABNORMAL FLUCTUATIONS	EAP 1-13
CROSSBLEED FAILURE.....	EAP 1-8
HIGH STAGE VALVE FAILURE	EAP 1-8
PACK OVERHEAT	EAP 1-9
PACK OVERLOAD	EAP 1-10
PACK VALVE CLOSED	EAP 1-11
PACK VALVE FAILURE.....	EAP 1-12
PRESSURIZATION AUTOMATIC SYSTEM FAILURE	EAP 1-13
RAM AIR VALVE FAILURE.....	EAP 1-14

NON ANNUNCIATED PROCEDURES

RAPID CABIN DEPRESSURIZATION	refer to NAP-11
LOSS OF PRESSURIZATION INDICATION.....	refer to NAP-27
SINGLE ENGINE BLEED OPERATION IN ICING CONDITIONS ..	refer to NAP-34

EMERGENCY/ABNORMAL PROCEDURES

Air Conditioning, Pneumatics & Pressurization

LIST OF EICAS MESSAGES

BLD APU LEAK	EAP 1-3
BLD 1 (2) LEAK	EAP 1-4
BLD 1 (2) OVTEMP	EAP 1-5
APU BLD VLV FAIL	EAP 1-5
BLD 1 (2) LOW TEMP	EAP 1-6
BLD 1 (2) VLV CLSD	EAP 1-7
BLD 1 (2) VLV FAIL	EAP 1-7
CROSS BLD FAIL.....	EAP 1-8
HS VLV 1 (2) FAIL	EAP 1-8
PACK 1 (2) OVHT	EAP 1-9
PACK 1 (2) OVLD	EAP 1-10
PACK 1 (2) VLV CLSD	EAP 1-11
PACK 1 (2) VLV FAIL	EAP 1-12
PRESN AUTO FAIL	EAP 1-13
RAM AIR VLV FAIL.....	EAP 1-14

User: aherrera - Printed By myTechCare - Jul 25/22 - 13:50:24

EMERGENCY/ABNORMAL PROCEDURES

Air Conditioning, Pneumatics & Pressurization

BLEED APU LEAK

EICAS Warning: BLD APU LEAK

APU Bleed PUSH OUT
Bleed 1 and 2 AS REQUIRED



..... WAIT 3 MINUTES

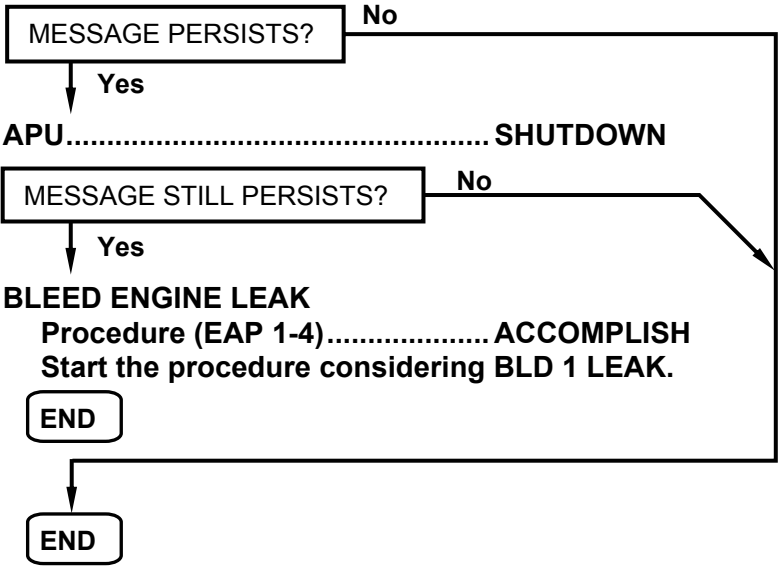

BLEED ENGINE LEAK
Procedure (EAP 1-4) ACCOMPLISH
Start the procedure considering BLD 1 LEAK.

END

END

User: aherrera - Printed By myTechCare - Jul 25/22 - 13:50:24

QRH-145/1115

EMERGENCY/ABNORMAL PROCEDURES

Air Conditioning, Pneumatics & Pressurization

BLEED ENGINE LEAK

EICAS Warning: BLD 1 (2) LEAK
Light: Red LEAK inscription in affected push button.

XBleed **CLOSED**
Affected Bleed **PUSH OUT**
APU Bleed **PUSH OUT**
Altitude **MAX 25'000 FT,**
MIN MEA
Icing Conditions **EXIT/AVOID**

 **WAIT 3 MINUTES**

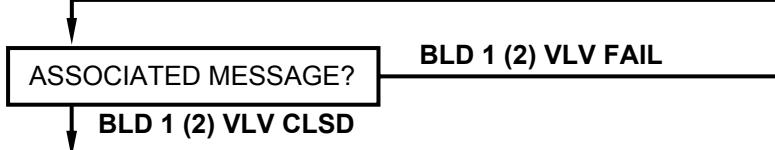

Opposite Bleed **PUSH OUT**
Associated Bleed **PUSH IN**
 **WAIT 3 MINUTES**

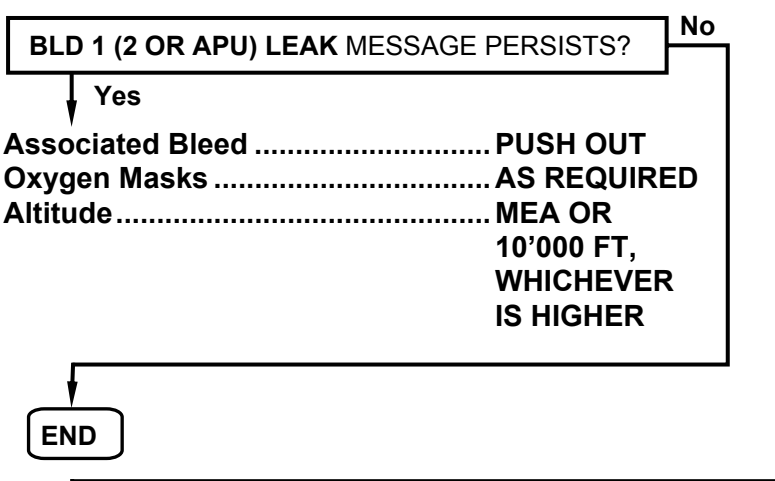

Associated Thrust Lever **IDLE**
 **WAIT 3 MINUTES**

CONTINUES ON NEXT PAGE

User: aherrera - Printed By myTechCare - Jul 25/22 - 13:50:24

EMERGENCY/ABNORMAL PROCEDURES

Air Conditioning, Pneumatics & Pressurization

CONTINUED FROM PREVIOUS PAGE

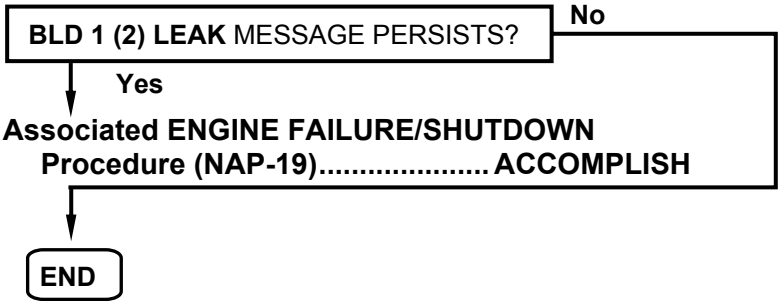

BLEED OVERTEMPERATURE

EICAS Warning: BLD 1 (2) OVTEMP

MFD Indication: Bleed Temp pointer may be in red range or out of view.

XBleed **OPEN**

Affected Bleed **PUSH OUT**

Altitude **MAX 25'000 FT,**
MIN MEA

SINGLE ENGINE BLEED OPERATION IN ICING CONDITIONS

Procedure (NAP-34)..... **AS REQUIRED**

END

APU BLEED VALVE FAILURE

EICAS Caution: APU BLD VLV FAIL

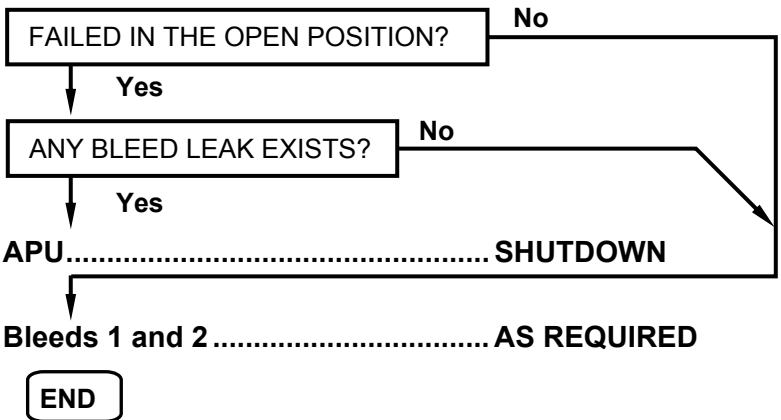

EMERGENCY/ABNORMAL PROCEDURES

Air Conditioning, Pneumatics & Pressurization

BLEED LOW TEMPERATURE

EICAS Caution: BLD 1 (2) LOW TEMP

MFD Indication: Pointer may be amber or may be out of view.

BLEED TEMP POINTER OUT OF VIEW OR IN GREEN RANGE?

No

Yes

Message DISREGARD

END

Ice Detection Override Knob ALL

Associated Thrust Lever ADVANCE

Adjust affected Thrust Lever until message disappears or pointer of the affected side reaches green range or matches the opposite pointer.



..... WAIT 1 MINUTE

MESSAGE PERSISTS?

No

Yes

Affected Bleed PUSH OUT

Altitude MAX 25'000 FT,
MIN MEA

ICING CONDITIONS?

No

Yes

XBleed OPEN

Altitude MAX 15'000 FT,
MIN MEA

If it is not possible to descend below 15'000 ft:

Ice Conditions EXIT



..... WAIT 2 MINUTES

Ice Detection Override Knob AUTO

END

Ice Detection Override Knob AUTO

END

EMERGENCY/ABNORMAL PROCEDURES

Air Conditioning, Pneumatics & Pressurization

BLEED VALVE CLOSED

EICAS Advisory: BLD 1 (2) VLV CLSD

Confirm the closed side and, if required and situation permits:

Associated Pack..... PUSH OUT, THEN
PUSH IN

Associated Bleed PUSH IN

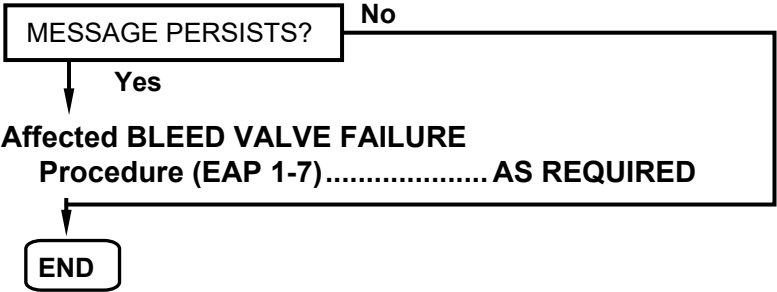

BLEED VALVE FAILURE

EICAS Caution: BLD 1 (2) VLV FAIL

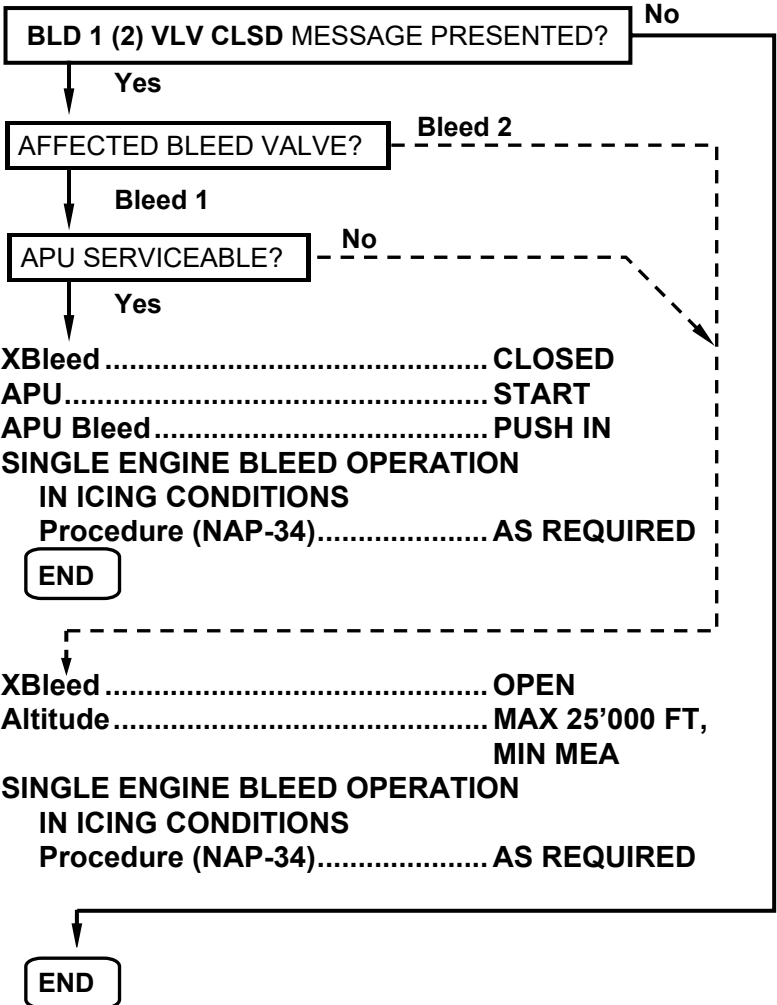

EMERGENCY/ABNORMAL PROCEDURES

Air Conditioning, Pneumatics & Pressurization

CROSSBLEED FAILURE

EICAS Caution: CROSS BLD FAIL

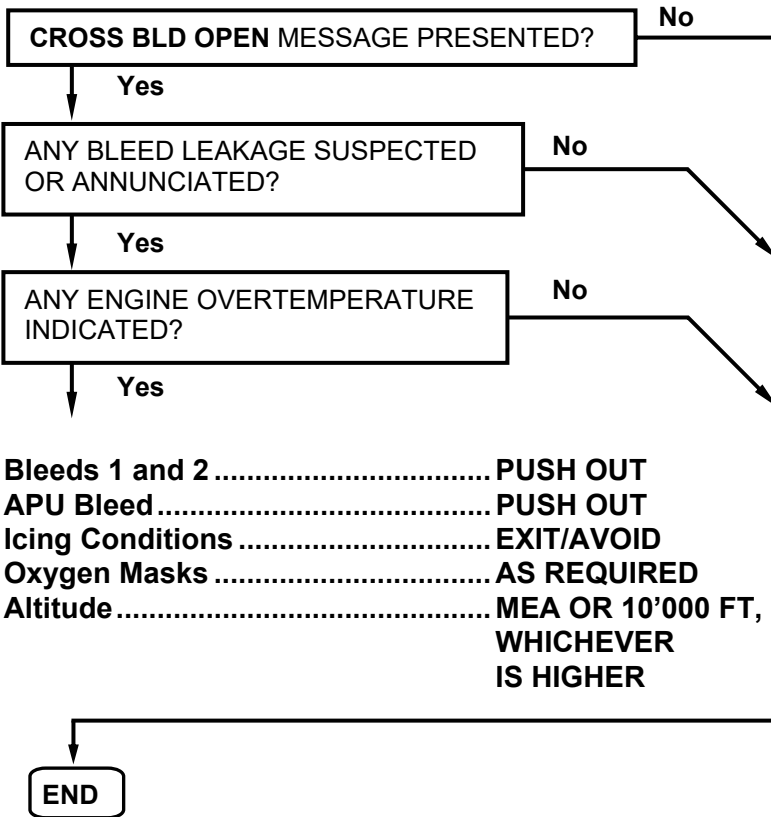

HIGH STAGE VALVE FAILURE

EICAS Caution: HS VLV 1 (2) FAIL

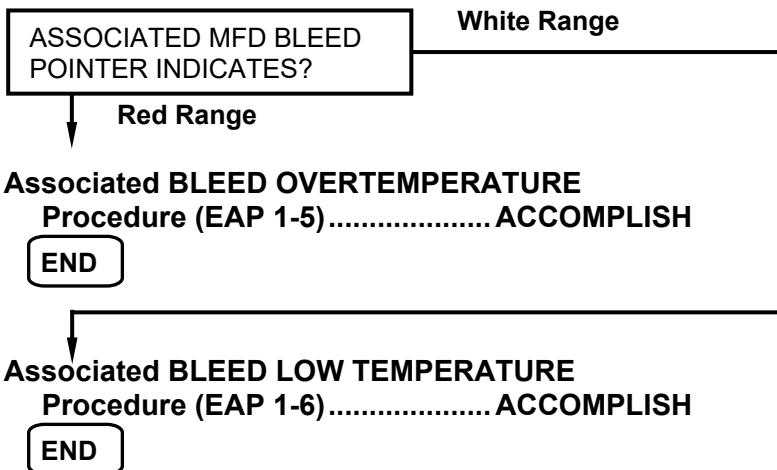

EMERGENCY/ABNORMAL PROCEDURES

Air Conditioning, Pneumatics & Pressurization

PACK OVERHEAT

EICAS Caution: PACK 1 (2) OVHT

Associated Temperature &

Mode SelectorAUTO/FULL COLD

Affected PackPUSH OUT



.....WAIT 3 MINUTES

Affected PackPUSH IN

MESSAGE PERSISTS?

No

Yes

Associated Temperature &

Mode SelectorMANUAL/FULL COLD

Affected PackPUSH OUT



.....WAIT 3 MINUTES

Affected PackPUSH IN

MESSAGE PERSISTS?

No

Yes

Affected PackPUSH OUT

BOTH PACKS AFFECTED?

No

Yes

Oxygen MasksAS REQUIRED

AltitudeMEA OR 10'000 FT,
WHICHEVER IS HIGHER

At least one bleed source must be kept open.

When reaching 10'000 ft:

CabinDEPRESSURIZE

END

AltitudeMAX 25'000 FT,
MIN MEA

END

END

EMERGENCY/ABNORMAL PROCEDURES

Air Conditioning, Pneumatics & Pressurization

PACK OVERLOAD

EICAS Caution: PACK 1 (2) OVLD

Recirculation Fan PUSH IN

Associated Temperature &
Mode Selector AUTO / 12 O'CLOCK
POSITION

Associated Pack PUSH OUT

 WAIT 3 MINUTES

Associated Pack PUSH IN

NOTE: In case the message remains displayed after reset,
report to the maintenance personnel.

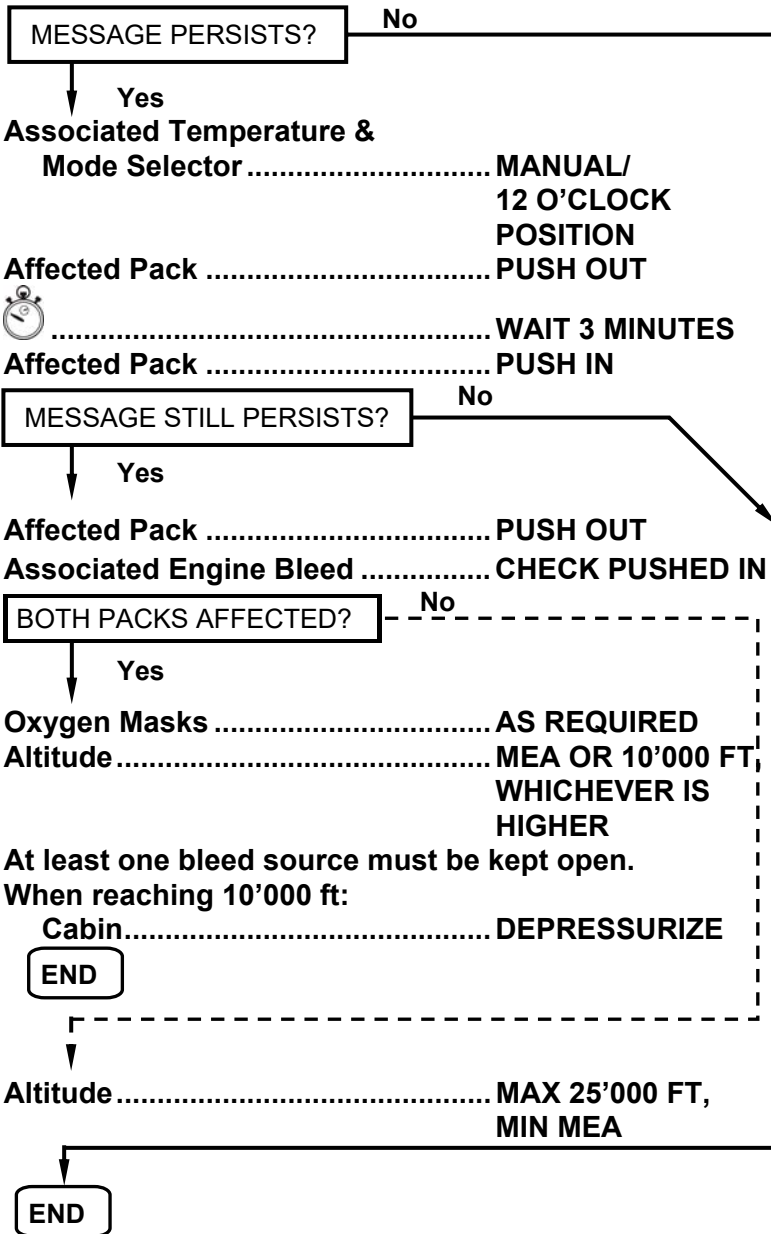

EMERGENCY/ABNORMAL PROCEDURES

Air Conditioning, Pneumatics & Pressurization

PACK VALVE CLOSED

EICAS Advisory: PACK 1 (2) VLV CLSD

Associated Pack..... **PUSH OUT, THEN
PUSH IN**

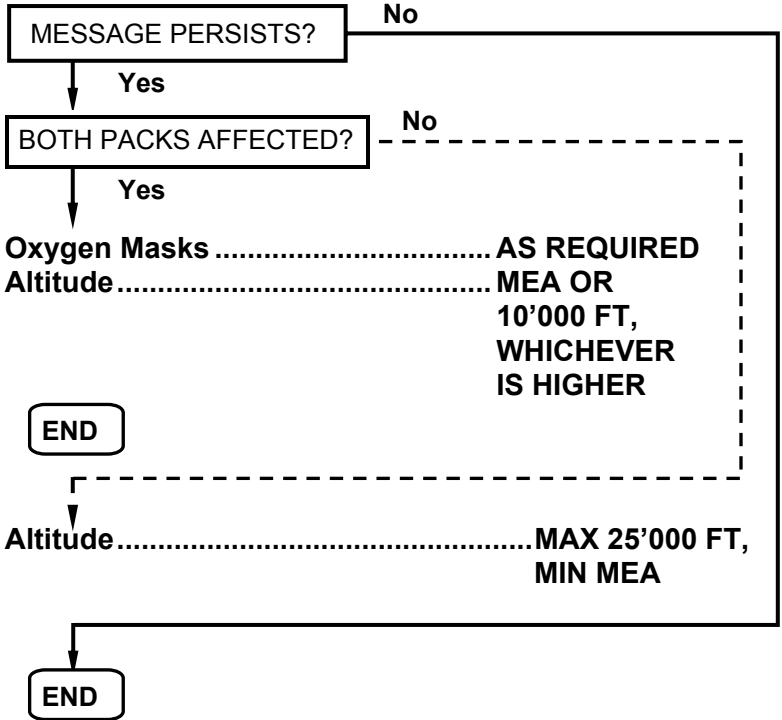

User: aherrera - Printed By myTechCare - Jul 25/22 - 13:50:24

EMERGENCY/ABNORMAL PROCEDURES

Air Conditioning, Pneumatics & Pressurization

PACK VALVE FAILURE

EICAS Caution: PACK 1 (2) VLV FAIL

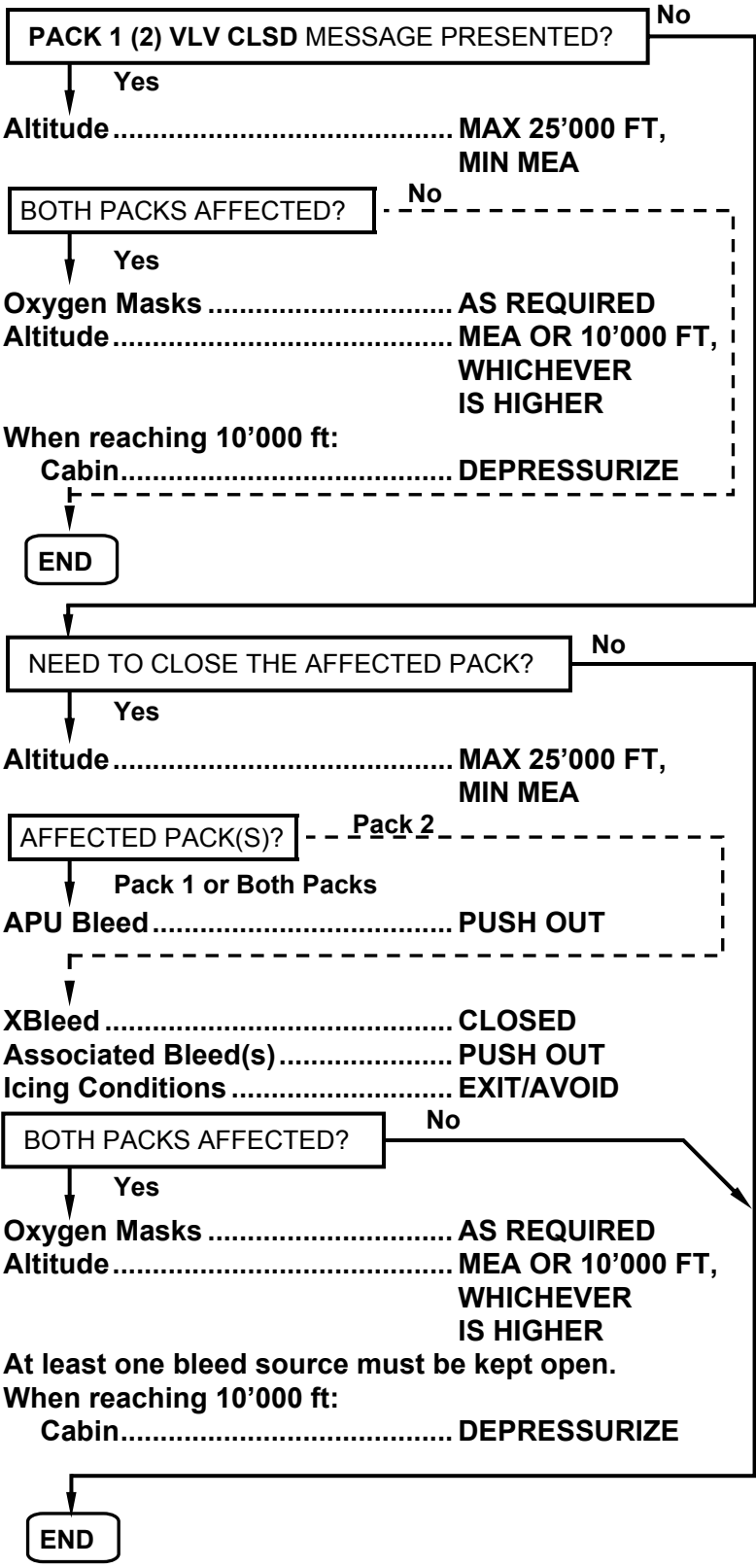

User: aherrera - Printed By myTechCare - Jul 25/22 - 13:50:24

EMERGENCY/ABNORMAL PROCEDURES

Air Conditioning, Pneumatics & Pressurization

PRESSURIZATION AUTOMATIC SYSTEM FAILURE/CABIN DEPRESSURIZATION/CABIN RATE ABNORMAL FLUCTUATIONS

EICAS Caution: PRESN AUTO FAIL may be presented.

EICAS Indication: Abnormal cabin altitude (amber or red) may be presented.
Erratic cabin rate fluctuations may be presented.

Pressurization Manual Controller 11 O'CLOCK POSITION

Pressurization Mode Selector PUSH IN (MAN)

Pressurization Manual Controller AS REQUIRED

Wait for system response and stabilization.

MANUAL CONTROL POSSIBLE?

No

Yes

Cabin Altitude CONTROL

Set and control cabin altitude according to the AIRPLANE/CABIN ALTITUDE conversion table on NAP-27.

NOTE: On ground, select the manual controller to full up to avoid residual cabin pressure interfering on the door and cockpit slide windows operation.

END

CABIN AURAL WARNING VOICE MESSAGE SOUNDS?

No

Yes

RAPID CABIN DEPRESSURIZATION

Procedure (NAP-11) ACCOMPLISH

END

Oxygen Masks AS REQUIRED
Altitude MEA OR
10'000 FT,
WHICHEVER
IS HIGHER

CONTINUES ON NEXT PAGE

EMERGENCY/ABNORMAL PROCEDURES

Air Conditioning, Pneumatics & Pressurization

CONTINUED FROM PREVIOUS PAGE

At least one bleed source must be kept open.

When reaching 10'000 ft:

Pressurization Manual Controller ...DOWN

Pressurization Mode SelectorPUSH OUT

Pressurization Dump ButtonPUSH IN (ON)

END

RAM AIR VALVE FAILURE

EICAS Caution: RAM AIR VLV FAIL

Air Conditioning SystemMONITOR

ANY PACK 1 (2) OVLD OR PACK 1 (2) OVHT
MESSAGE PRESENTED?

No

Yes

Associated Pack.....PUSH OUT
Altitude.....MAX 25'000 FT,
MIN MEA

BOTH PACKS AFFECTED?

No

Yes

Oxygen Masks AS REQUIRED
Altitude..... MEA OR 10'000 FT,
WHICHEVER
IS HIGHER

At least one bleed source must be kept open.

When reaching 10'000 ft:

Cabin.....DEPRESSURIZE

END

TABLE OF CONTENTS ANNUNCIATED PROCEDURES

AUTOPILOT FAILURE	EAP 2-3
AHRS ALIGNMENT FAULT	EAP 2-3
AHRS ATTITUDE MODE	EAP 2-3
AHRS FAIL.....	EAP 2-4
AHRS ON BATTERY	EAP 2-4
AHRS OVERHEAT	EAP 2-4
AUTOPILOT AILERON MISTRIM.....	EAP 2-5
AUTOPILOT ELEVATOR MISTRIM.....	EAP 2-5
AUTOPILOT TRIM FAILED.....	EAP 2-6
DAU FAILURE	EAP 2-6
DAU MISCOMPARE	EAP 2-7
DISPLAY FAILURE.....	EAP 2-8
ELECTRONIC BAY OVERTEMPERATURE.....	EAP 2-9
FD LATERAL MODE OFF.....	EAP 2-11
FD VERTICAL MODE OFF	EAP 2-11
IC BUS FAILURE	EAP 2-11
IC FAILURE	EAP 2-11
IC OVERHEAT	EAP 2-12
IRS ALIGNMENT	EAP 2-12
IRS ALIGNMENT FAULT	EAP 2-13
IRS ATTITUDE MODE	EAP 2-13
IRS FAIL.....	EAP 2-14
IRS ON BATTERY	EAP 2-14
IRS OVERHEAT	EAP 2-15
RADIO ALTIMETER FAIL	EAP 2-16
YAW DAMPER FAILURE.....	EAP 2-16

NON ANNUNCIATED PROCEDURES

APPROACH WARNING.....	refer to NAP-14
CAS MESSAGE MISCOMPARISON	refer to NAP-14
IRS/MSU FAILURE ANNUNCIATION	refer to NAP-25
NAV/FLIGHT INSTRUMENTS FAILURE	refer to NAP-28

EMERGENCY/ABNORMAL PROCEDURES

Autopilot, Flight Instruments & Navigation

LIST OF EICAS MESSAGES

AUTOPILOT FAIL	EAP 2-3
AHRS 1 (2) ALN FAULT	EAP 2-3
AHRS 1 (2) FAIL	EAP 2-4
AHRS 1 (2) OVERHEAT	EAP 2-4
AP AIL MISTRIM	EAP 2-5
AP ELEV MISTRIM	EAP 2-5
AUTO TRIM FAIL	EAP 2-6
CHECK PFD 1 (2)	EAP 2-8
DAU1 (2) A FAIL	EAP 2-6
DAU1 (2) ENG MISCOMP	EAP 2-7
DAU1 (2) SYS MISCOMP	EAP 2-7
DAU1 (2) WRN MISCOMP	EAP 2-7
ELEKBAY OVTEMP	EAP 2-9
IC BUS FAIL	EAP 2-11
IC 1 (2) OVERHEAT	EAP 2-12
LATERAL MODE OFF	EAP 2-11
IRS 1 (2) ALN FAULT	EAP 2-13
IRS 1 (2) FAIL	EAP 2-14
IRS 1 (2) OVERHEAT	EAP 2-15
VERTICAL MODE OFF	EAP 2-11
YAW DAMPER FAIL	EAP 2-16
AHRS 1 (2) ATT MODE	EAP 2-3
AHRS 1 (2) ON BATT	EAP 2-4
DAU1 (2) B FAIL	EAP 2-6
IRS 1 (2) ALN	EAP 2-12
IRS 1 (2) ATT MODE	EAP 2-13
IRS 1 (2) ON BATT	EAP 2-14
RAD ALT 1 (2) FAIL	EAP 2-16
RAD ALT FAIL	EAP 2-16

EMERGENCY/ABNORMAL PROCEDURES

Autopilot, Flight Instruments & Navigation

AUTOPILOT FAILURE

EICAS Warning: AUTOPILOT FAIL

Aural Warning: AUTOPILOT Voice message

AutopilotDISENGAGE

Trim the airplane as required.

NOTE: If associated with autopilot hardover a sudden deviation from the expected flight path may occur.

END

AHRS ALIGNMENT FAULT

EICAS Caution: AHRS 1 (2) ALN FAULT

Check and reenter present position. If necessary, reenter present position once again.

END

AHRS ATTITUDE MODE

EICAS Advisory: AHRS 1 (2) ATT MODE

CROSS-SIDE AHRS AVAILABLE?

No

Yes

AHRS Button on Associated Reversionary PanelPUSH IN

END

Maintain wings level and constant airspeed until AHRS 1 (2) ALN message is no longer displayed and attitude is recovered (approximately 20 seconds).

CAUTION:

- ATTITUDE OUTPUTS ARE NOT AS ACCURATE AS IN THE NORMAL OPERATIONAL MODE.
- AHRS MAGNETIC HEADING IS NOT AVAILABLE.

NOTE: The Autopilot is not available while AHRS 1 (2) ALN message is being displayed.

END

EMERGENCY/ABNORMAL PROCEDURES

Autopilot, Flight Instruments & Navigation

AHRS FAIL

EICAS Caution: AHRS 1 (2) FAIL

Relevant Inoperative Item: **Autopilot**

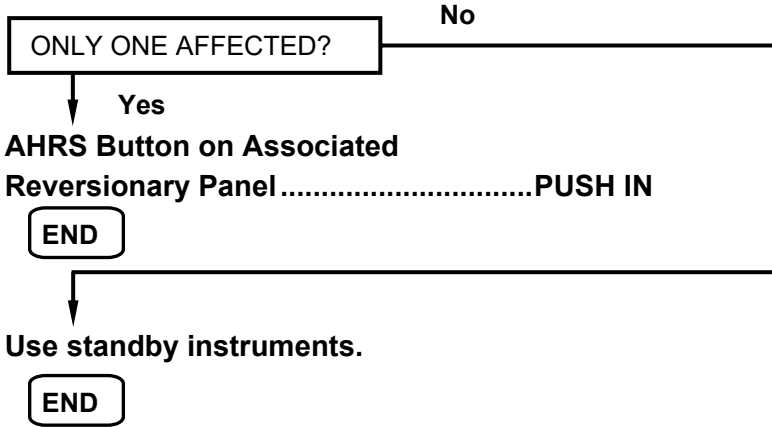

AHRS ON BATTERY

EICAS Advisory: AHRS 1 (2) ON BATT

Affected AHRS will operate for 40 minutes.

END

AHRS OVERHEAT

EICAS Caution: AHRS 1 (2) OVERHEAT

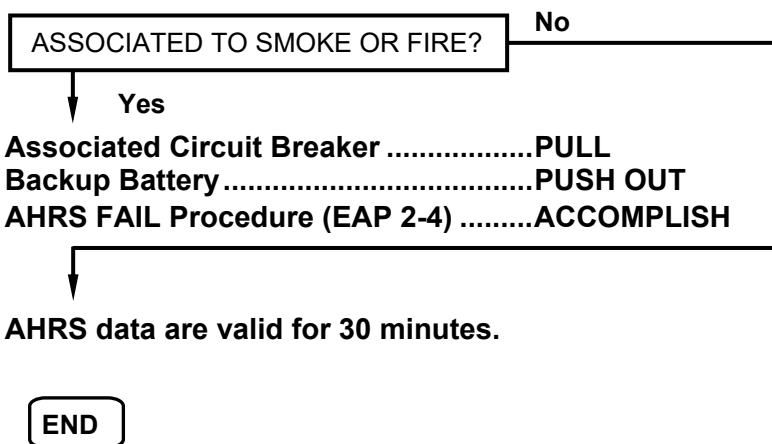

EMERGENCY/ABNORMAL PROCEDURES

Autopilot, Flight Instruments & Navigation

AUTOPILOT AILERON MISTRIM

EICAS Caution: AP AIL MISTRIM for more than 10 s.

Condition: Autopilot is engaged with aileron out of trim.

Control Wheel.....**HOLD FIRMLY**
Quick Disconnect Button**PRESS**
Roll Trim.....**AS REQUIRED**
Yaw Trim**AS REQUIRED**
Autopilot**AS REQUIRED**

END

AUTOPILOT ELEVATOR MISTRIM

EICAS Caution: AP ELEV MISTRIM

Condition: Autopilot is engaged with pitch out of trim.

Control Column.....**HOLD FIRMLY**
Quick Disconnect Button**PRESS**
Pitch Trim.....**AS REQUIRED**
Autopilot**AS REQUIRED**

END

EMERGENCY/ABNORMAL PROCEDURES

Autopilot, Flight Instruments & Navigation

AUTOPILOT TRIM FAILED

EICAS Caution: AUTO TRIM FAIL

Control Column**HOLD FIRMLY**

Quick Disconnect Button**PRESS**

Pitch Trim.....**AS REQUIRED**

Autopilot**AS REQUIRED**

END

DAU FAILURE

EICAS Caution: DAU1 (2) A FAIL

EICAS Advisory: DAU1 (2) B FAIL

ONLY CHANNEL B AFFECTED?

No

Yes

END

ONLY CHANNEL A AFFECTED?

No

Yes

Associated DAU on EICAS Rev (Pedestal Panel)**PUSH IN**

WHICH DAU IS AFFECTED?

DAU 2

DAU 1

- **Lost Indications:** engine 1 oil (temperature and pressure), battery 1 and 2 temperature, fuel tank temperature, roll trim position, cockpit temperature and bleed 1 temperature.
- **Lost Messages:** FUEL TANK LO TEMP, E1 FUEL LO TEMP, BLEED 1 OVTEMP.
- BLD 1 LOW TEMP message will appear.

END

- **Lost Indications:** engine 2 oil (temperature and pressure), hydraulic quantity 1 and 2, yaw trim position, cabin temperature and bleed 2 temperature.
- **Lost Messages:** BLEED 2 OVTEMP, E2 FUEL LO TEMP, HYD 1 LO QTY, HYD 2 LO QTY.
- BLD 2 LOW TEMP message will appear.
- APU OIL HI TEMP message will appear in case APU is OFF.

END

CONTINUES ON NEXT PAGE

EMERGENCY/ABNORMAL PROCEDURES

Autopilot, Flight Instruments & Navigation

CONTINUED FROM PREVIOUS PAGE

LAND AT THE NEAREST SUITABLE AIRPORT.

WHICH DAU IS AFFECTED?

DAU 2

DAU 1

- **All messages and indications of the following systems are lost:** Oxygen, Steering, Landing Gear, Roll Trim, and the message EMERG LIGHT NOT ARMED.
- **Some messages and indications of the following system are lost:** Doors, Stall Protection, Electrical, Fire Protection, Fuel, APU, Power Plant, Thrust Reverser, Spoiler, Brakes, Air Conditioning, Ice and Rain Protection.

END

- **All messages and indications of the following systems are lost:** Smoke, Hydraulic, Rudder and Yaw Trim.
- **Some messages and indications of the following systems are lost:** Doors, Stall Protection, Electrical, Fire Protection, Fuel, APU, Power Plant, Thrust Reverser, Flap, Brakes, Air Conditioning, Ice and Rain Protection.

END

DAU MISCOMPARE

EICAS Caution: DAU1 (2) ENG MISCOMP or
DAU1 (2) SYS MISCOMP or
DAU1 (2) WRN MISCOMP

**Associated DAU on
EICAS Rev (Pedestal Panel)PUSH IN**

Analyze the situation before and after the reversion, and take the appropriate corrective action.

- NOTE:** For each miscompare message and each side, check the following parameters before and after the reversion:
- Engine: N1, N2, ITT.
 - System: Battery voltage and temperature, Takeoff temperature, Hydraulic pressure, Oxygen pressure.
 - Warning: all warning messages, if any.

END

EMERGENCY/ABNORMAL PROCEDURES

Autopilot, Flight Instruments & Navigation

DISPLAY FAILURE

EICAS Caution: CHECK PFD 1 (2) message is presented if PFD is the failed display.

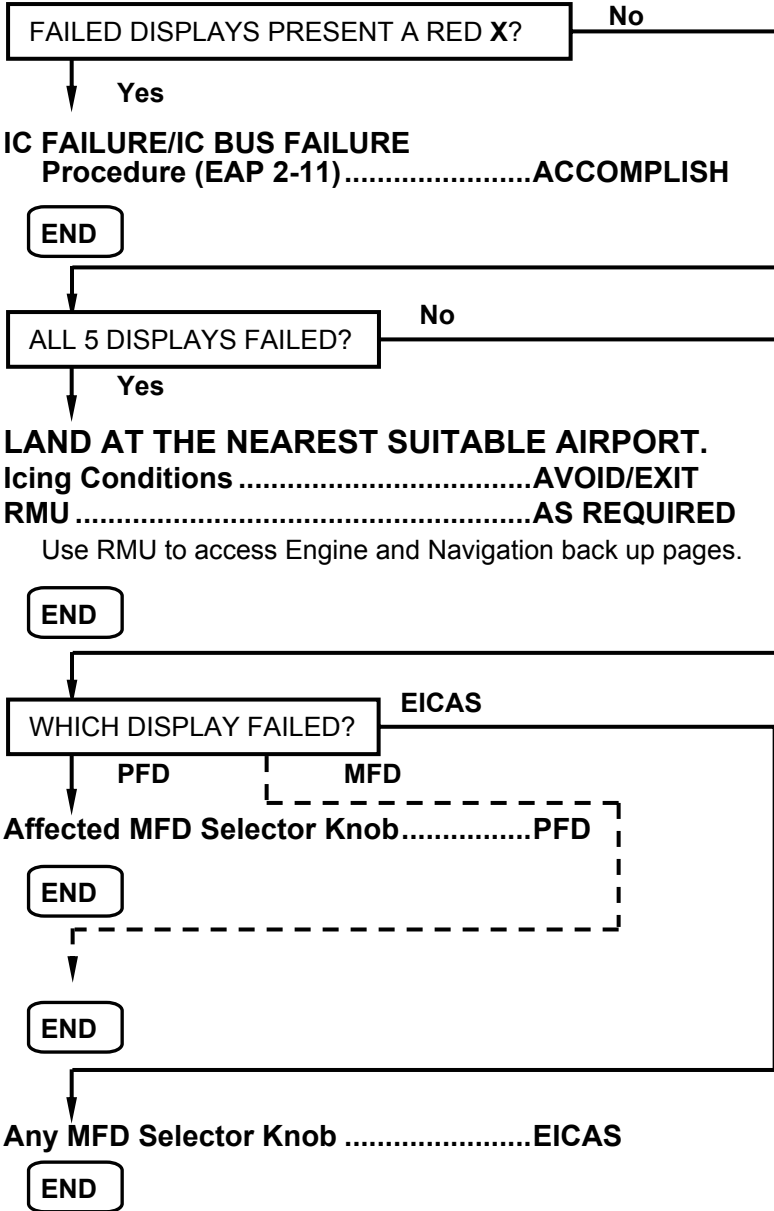

User: aherrera - Printed By myTechCare - Jul 25/22 - 13:50:24

EMERGENCY/ABNORMAL PROCEDURES

Autopilot, Flight Instruments & Navigation

ELECTRONIC BAY OVERTEMPERATURE

EICAS Caution: ELEKBAY OVTEMP

The following equipment is installed in the forward electronic compartment:

- Air Data Computer (ADC);
- Transponder Mode S;
- Integrated Communication Unit (ICU);
- Aural Warning Computer (AWC);
- Flight Management System (FMS);
- Attitude and Heading Reference System (AHRS);
- Passenger Address;
- Integrated Navigation Unit (INU);
- Inverters;
- Dimmers;
- Backup Battery.

It is recommended to turn off the systems that are unessential, using the table below to assess which system could be turned off. Turn off only systems that are unessential to the present phase of flight.

SYSTEM	POWER OFF CONTROL
Passenger Address	PA CB PULL
Dimmers	Panel lights knob (pilot, pedestal and copilot) at left and right side of the glareshield panel OFF OR PUSH BUTTONS CB PULL
Integrated Navigation Unit	For INU 1: ADF 1 CB , DME 1 CB and VOR/ILS 1 CB PULL OR For INU 2: ADF 2 CB , DME 2 CB and VOR/ILS 2 CB PULL
Inverters	Push out AC PWR Push Button on overhead Electrical System panel. NOTE: TCAS and GPWS/Windshear may use 115V AC.

CONTINUES ON NEXT PAGE

EMERGENCY/ABNORMAL PROCEDURES

Autopilot, Flight Instruments & Navigation

CONTINUED FROM PREVIOUS PAGE

MESSAGE PERSISTS?

No

Yes

It is recommended to turn off the redundant system and unessential equipment, using the table below to assess which system or equipment could be turned off. Turn off only systems and equipment that are unessential to the present phase of flight.

SYSTEM	POWER OFF CONTROL
FMS	<ul style="list-style-type: none"> - For Honeywell FMS: - For FMS 1: CMPTR 1 CB. - For FMS 2: CMPTR 2 CB. - For Universal FMS: - FMS 1 CB. - FMS 2 CB. <p>NOTE: Some airplanes may not be equipped with dual FMS.</p>
Aural Warning Computer	AWS CB.
Transponder Mode S	<ul style="list-style-type: none"> - For Transponder 1: XPDR 1 CB. - For Transponder 2: XPDR 2 CB.
Integrated Communication Unit	<ul style="list-style-type: none"> - For ICU 1: XPDR 1 CB and VHF 1 CB. - For ICU 2: XPDR 2 CB and VHF 2 CB.
Attitude and Reference System	<ul style="list-style-type: none"> - AHRS 1 CB. - AHRS 2 CB.
Air Data Computer	<ul style="list-style-type: none"> - ADC 1 CB. - ADC 2 CB.
Backup Battery	Backup Power Push Button on overhead Electrical System panel.

MESSAGE PERSISTS?

No

Yes

LAND AT THE NEAREST SUITABLE AIRPORT.

Maintain a cross-check between main and standby instruments. In case of disagreement, follow the standby instruments indication.

END

EMERGENCY/ABNORMAL PROCEDURES

Autopilot, Flight Instruments & Navigation

FD LATERAL MODE OFF/ FD VERTICAL MODE OFF

EICAS Caution: LATERAL MODE OFF or
VERTICAL MODE OFF

At crew discretion, re-select the affected Flight Director or select the other.

NOTE: For some EICAS versions this message will be presented if the crew turns the Flight Director off. In this case, the message must be disregarded.

END

IC FAILURE/IC BUS FAILURE

EICAS Caution: IC BUS FAIL may be presented.

Condition: Associated Display Units present a red X.

The following features will be inoperative:

- EICAS messages miscompare monitoring.
- Takeoff speeds synchronization.
- Flight Director mode synchronization.

FAILED DISPLAYS?

PFD 2 and MFD 2 (IC 2 Failed)

PFD 1, MFD 1 and EICAS (IC 1 Failed)

SG on Reversionary Panel 1PUSH IN

NOTE: - The PIT TRIM 1 (2) INOP or PTRIM MAIN INOP and PTRIM BACKUP INOP messages may not be available, and
- The autopilot is not available.

END

SG on Reversionary Panel 2PUSH IN

END

EMERGENCY/ABNORMAL PROCEDURES

Autopilot, Flight Instruments & Navigation

IC OVERHEAT

EICAS Caution: IC 1 (2) OVERHEAT

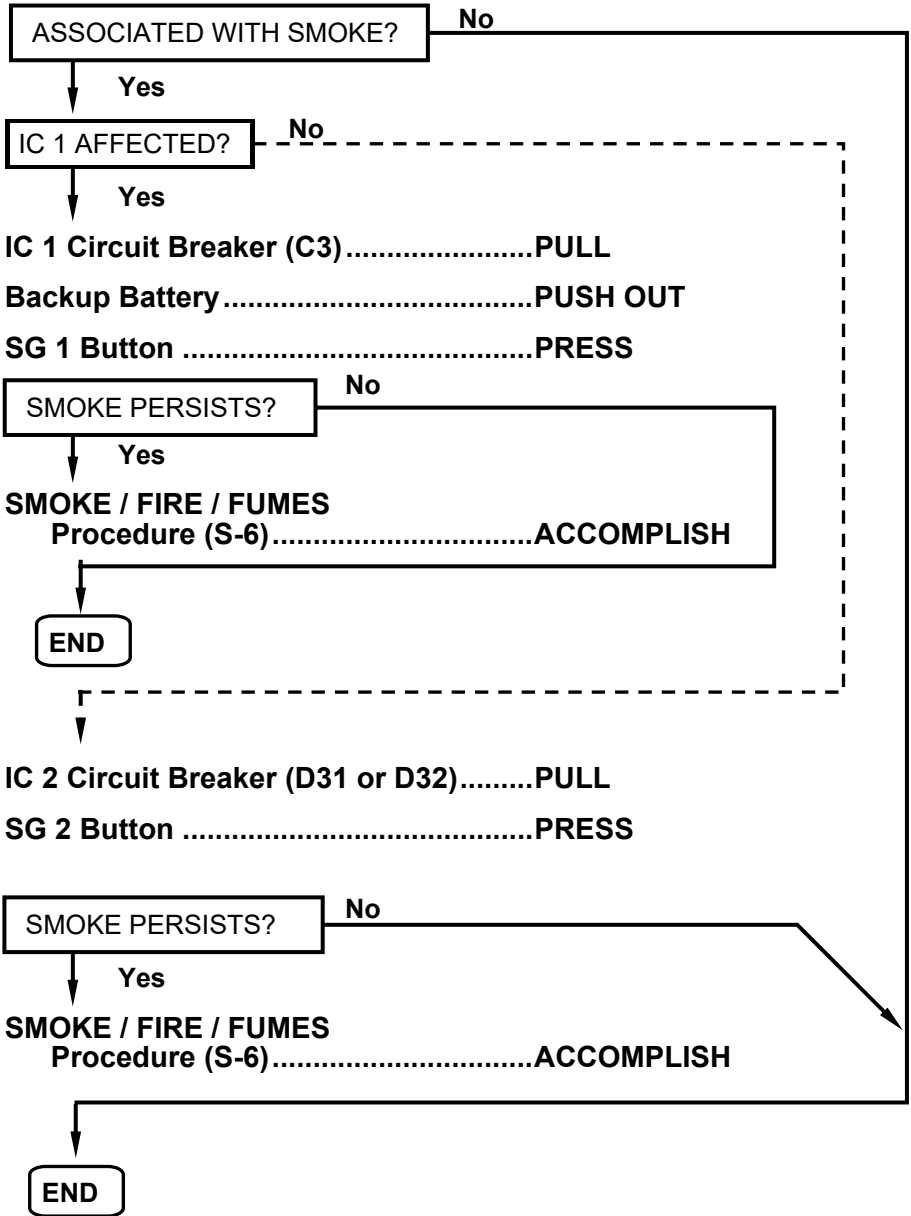

IRS ALIGNMENT

EICAS Advisory: IRS 1 (2) ALN

IRU mode select switch.....CHECK NAV

This message is only presented during alignment phase or while the IRU mode select switch is set at ALIGN position.

END

EMERGENCY/ABNORMAL PROCEDURES

Autopilot, Flight Instruments & Navigation

IRS ALIGNMENT FAULT

EICAS Caution: IRS 1 (2) ALN FAULT

Check and reenter present position. If necessary, reenter present position once again.

END

IRS ATTITUDE MODE

EICAS Advisory: IRS 1 (2) ATT MODE

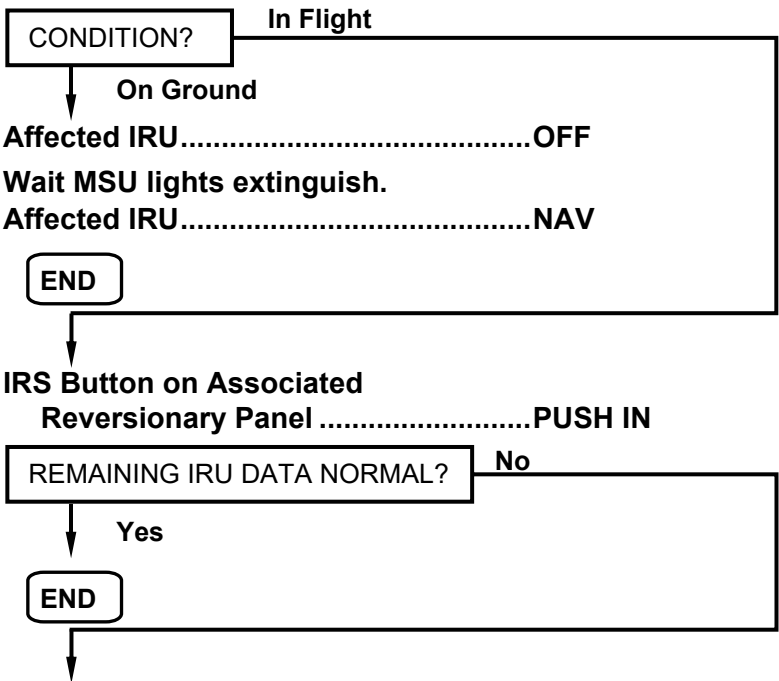

Maintain wings level and constant airspeed for approximately 20 seconds until IRS 1 (2) ALN message is no longer displayed and attitude is recovered.

Magnetic HeadingENTER

CAUTION: FOR IRS IN ATTITUDE MODE, NAVIGATION AND ATTITUDE OUTPUTS ARE NOT AS ACCURATE AS IN THE NAV MODE. MAGNETIC HEADING MUST BE ENTERED AND UPDATED PERIODICALLY FROM THE BEST AVAILABLE ALTERNATIVE SOURCE, THROUGH THE FMS CDU.

Relevant Inoperative Item: Autopilot

END

EMERGENCY/ABNORMAL PROCEDURES

Autopilot, Flight Instruments & Navigation

IRS FAIL

EICAS Caution: IRS 1 (2) FAIL

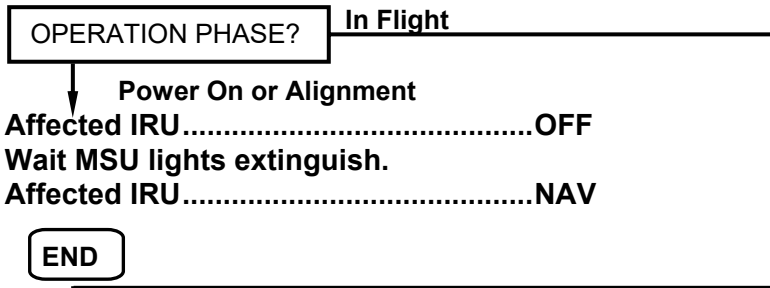

IRS Button on Associated Reversionary PanelPUSH IN



Affected IRU.....ATT

Maintain wings level and constant airspeed for approximately 20 seconds until IRS 1 (2) ALN message is no longer displayed and attitude is recovered.

Magnetic HeadingENTER

CAUTION: FOR IRS IN ATTITUDE MODE, NAVIGATION AND ATTITUDE OUTPUTS ARE NOT AS ACCURATE AS IN THE NAV MODE. MAGNETIC HEADING MUST BE ENTERED AND UPDATED PERIODICALLY FROM THE BEST AVAILABLE ALTERNATIVE SOURCE, THROUGH THE FMS CDU.

Relevant Inoperative Item: Autopilot

END

IRS ON BATTERY

EICAS Advisory: IRS 1 (2) ON BATT

Associated IRU will operate for 40 minutes.

END

EMERGENCY/ABNORMAL PROCEDURES

Autopilot, Flight Instruments & Navigation

IRS OVERHEAT

EICAS Caution: IRS 1 (2) OVERHEAT

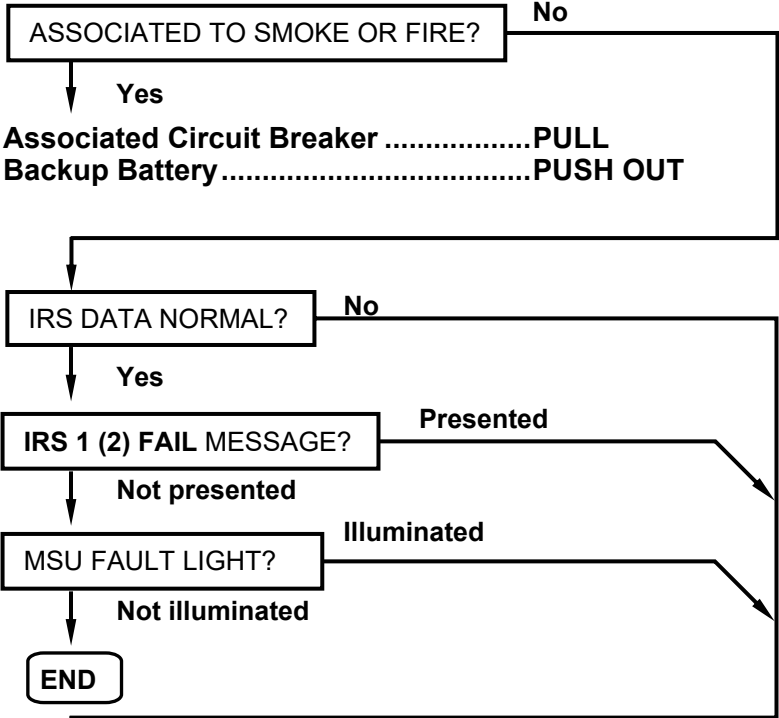

IRS Button on Associated

Reversionary PanelPUSH IN

Affected IRUOFF

AutopilotDISENGAGE

During final approach, if additional attitude reference is necessary:

Affected IRUATT

For IRS in ATT mode, navigation and attitude outputs are not as accurate as in the NAV mode. Magnetic heading must be entered and updated periodically from the best available alternative source, through the FMS CDU.

Relevant Inoperative Item: Autopilot

END

EMERGENCY/ABNORMAL PROCEDURES

Autopilot, Flight Instruments & Navigation

RADIO ALTIMETER FAIL

EICAS Advisory: RAD ALT 1 (2) FAIL or
RAD ALT FAIL may be presented.

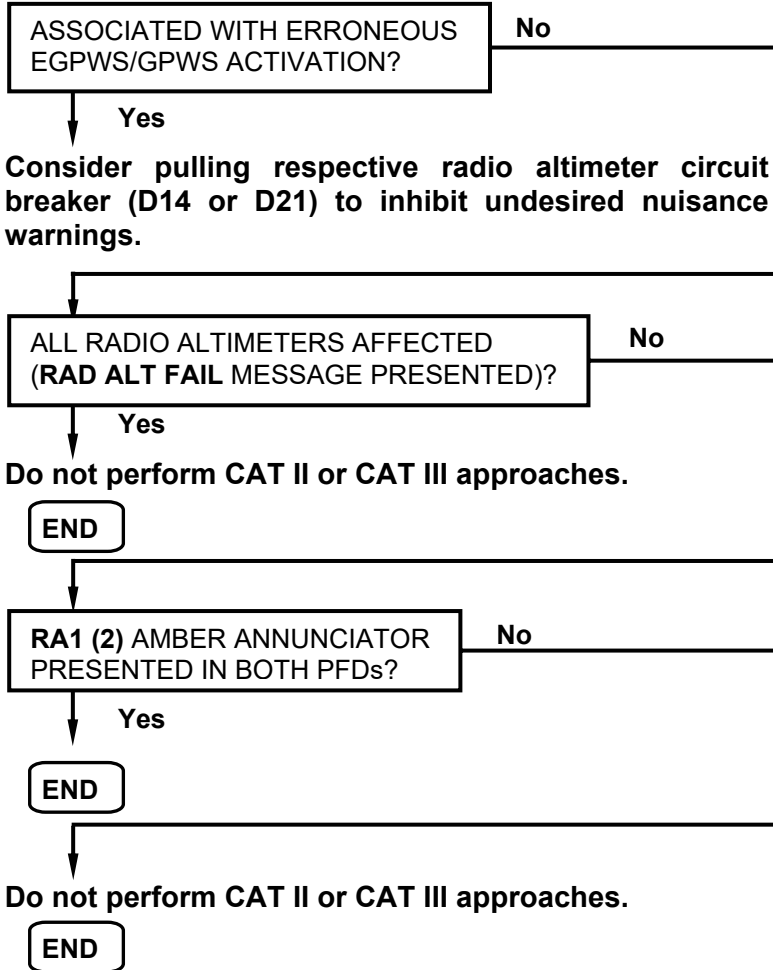

YAW DAMPER FAILURE

EICAS Caution: YAW DAMPER FAIL

Yaw Damper.....**DISENGAGE**
Autopilot**AS REQUIRED**

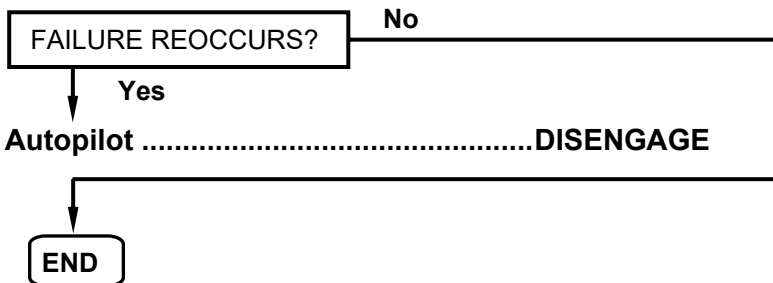

TABLE OF CONTENTS

ANNUNCIATED PROCEDURES

APU FIRE EAP 3-3
BLEED APU LEAK.....refer to EAP 1-3
APU BLEED VALVE FAILURE.....refer to EAP 1-5
APU CONTACTOR CLOSED EAP 3-4
APU FAIL..... EAP 3-4
APU FUEL LOW PRESSURE EAP 3-4
APU FUEL SHUTOFF VALVE
INOPERATIVErefer to EAP 9-4
APU OIL LOW PRESSURE EAP 3-5
APU OIL HIGH TEMPERATURE EAP 3-5

NON ANNUNCIATED PROCEDURES

APU OVERTEMPERATURErefer to NAP-4

User: aherrera - Printed By myTechCare - Jul 25/22 - 13:50:24

EMERGENCY/ABNORMAL PROCEDURES

Auxiliary Power Unit

LIST OF EICAS MESSAGES

APU FIRE	EAP 3-3
BLD APU LEAK	refer to EAP 1-3
APU BLD VLV FAIL	refer to EAP 1-5
APU CNTOR CLSD	EAP 3-4
APU FAIL.....	EAP 3-4
APU FUEL LO PRESS.....	EAP 3-4
APU FUEL SOV INOP	refer to EAP 9-4
APU OIL LO PRESS.....	EAP 3-5
APU OIL HI TEMP	EAP 3-5

User: aherrera - Printed By myTechCare - Jul 25/22 - 13:50:24

EMERGENCY/ABNORMAL PROCEDURES

Auxiliary Power Unit

APU FIRE

EICAS Warning: APU FIRE
Aural Warning: BELL

APU Fuel Shutoff Button PUSH IN

LAND AT THE NEAREST SUITABLE AIRPORT.

APU Master Knob OFF

APU FUEL SOV CLSD MESSAGE?

Presented

Not Presented

XFeed OFF

Fuel Pump Pwr 2 OFF

Initiate the descent to MEA or 25'000 ft, whichever is higher.



..... WAIT 30 SECONDS

APU FIRE MESSAGE PERSISTS OR
APU FIREDET FAIL IS DISPLAYED?

No

Yes

APU Fire Extinguishing Button..... PRESS

WARNING: DO NOT ATTEMPT TO RESTART APU.

END

EMERGENCY/ABNORMAL PROCEDURES

Auxiliary Power Unit

APU CONTACTOR CLOSED

EICAS Caution: APU CNTOR CLSD

Bus Ties **OFF**

Battery 2 **OFF**

END

APU FAIL

EICAS Caution: APU FAIL

Condition: APU automatically shuts down.

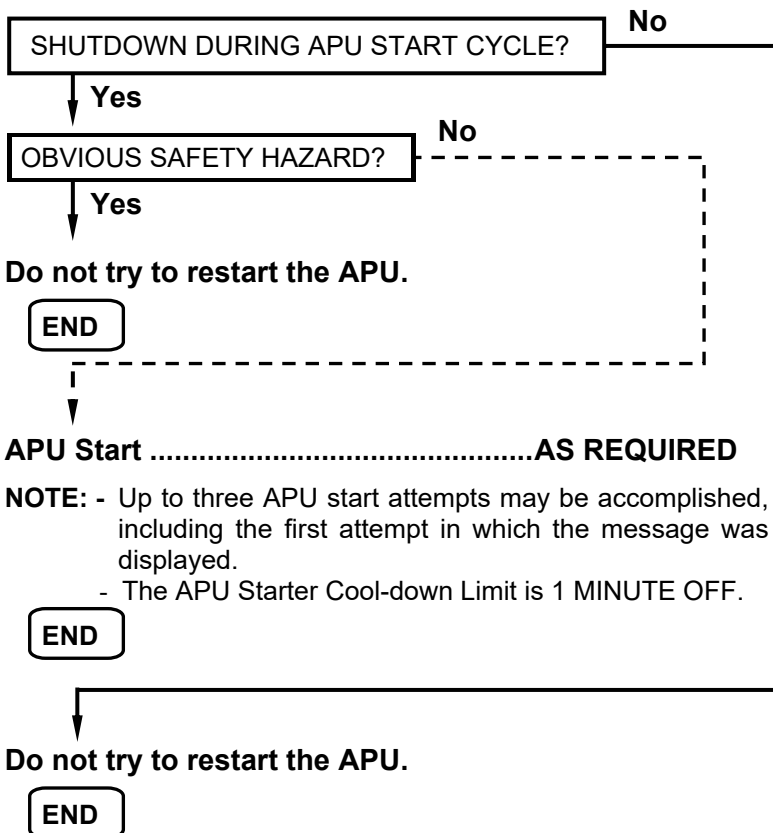

APU FUEL LOW PRESSURE

EICAS Caution: APU FUEL LO PRESS

Fuel Pump Sel 2 **SELECT ANOTHER**
If the message persists, repeat the procedure.

END

**APU OIL LOW PRESSURE/
APU OIL HIGH TEMPERATURE**

EICAS Caution: APU OIL LO PRESS and/or
APU OIL HI TEMP

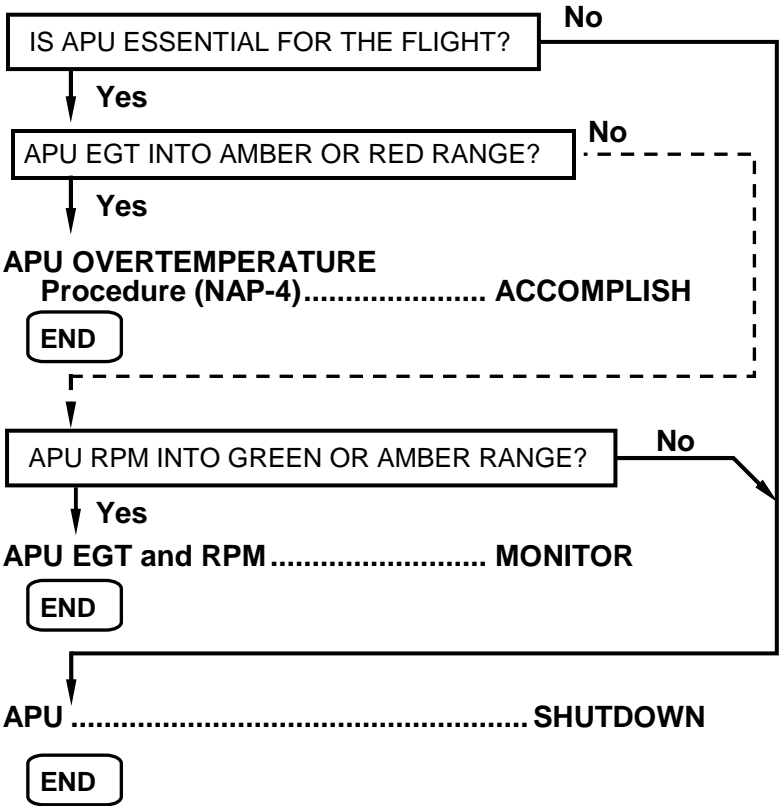

User: aherrera - Printed By myTechCare - Jul 25/22 - 13:50:24

EMERGENCY/ABNORMAL PROCEDURES

Auxiliary Power Unit

INTENTIONALLY BLANK

TABLE OF CONTENTS

ANNUNCIATED PROCEDURES

MAIN DOOR OPEN	EAP 4-3
SERVICE DOOR OPEN.....	EAP 4-3
ACCESS DOORS OPEN	EAP 4-4
BAGGAGE DOOR OPEN	EAP 4-4
EMERGENCY EXIT OPEN	EAP 4-5

NON ANNUNCIATED PROCEDURES

MAIN DOOR BLOCKED	refer to NAP-28
--------------------------------	------------------------

User: aherrera - Printed By myTechCare - Jul 25/22 - 13:50:24

EMERGENCY/ABNORMAL PROCEDURES

Doors

LIST OF EICAS MESSAGES

MAIN DOOR OPN	EAP 4-3
SERVICE DOOR OPN.....	EAP 4-3
ACCESS DOORS OPN	EAP 4-4
BAGGAGE DOOR OPN	EAP 4-4
EMERG EXIT OPN	EAP 4-5

User: aherrera - Printed By myTechCare - Jul 25/22 - 13:50:24

MAIN OR SERVICE DOOR OPEN

EICAS Warning: MAIN DOOR OPN or SERVICE DOOR OPN

MFD Indication: Red DOOR OPEN

FSTN Belts ON

Door Alignment Red Marks CHECK

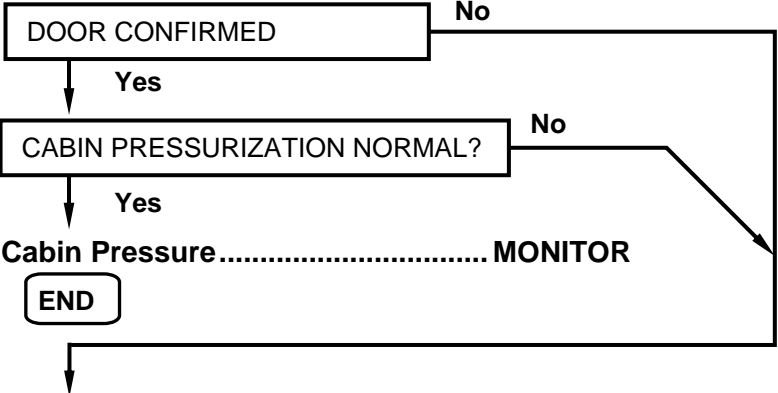

LAND AT THE NEAREST SUITABLE AIRPORT.

Oxygen Masks AS REQUIRED

**Altitude MEA OR 10'000 FT,
WHICHEVER IS HIGHER**

When reaching 10'000 ft:

Cabin DEPRESSURIZE

END

User: aherrera - Printed By myTechCare - Jul 25/22 - 13:50:24

EMERGENCY/ABNORMAL PROCEDURES

Doors

ACCESS/BAGGAGE DOORS OPEN

EICAS Caution: ACCESS DOORS OPN or
BAGGAGE DOOR OPN

MFD Indication: Red DOOR OPEN

Abrupt Maneuvers..... AVOID

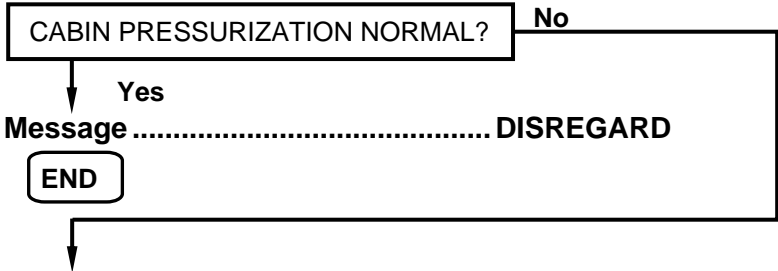

LAND AT THE NEAREST SUITABLE AIRPORT.

Oxygen Masks..... AS REQUIRED

**Altitude..... MEA OR 10'000 FT,
WHICHEVER
IS HIGHER**

When reaching 10'000 ft:

Cabin..... DEPRESSURIZE

END

EMERGENCY EXIT OPEN

EICAS Caution: EMERG EXIT OPN

MFD Indication: Red DOOR OPEN

FSTN Belts ON

Affected Exit CHECK

Remove passenger(s) from exit vicinity.

Emergency exit handle CHECK PUSHED IN

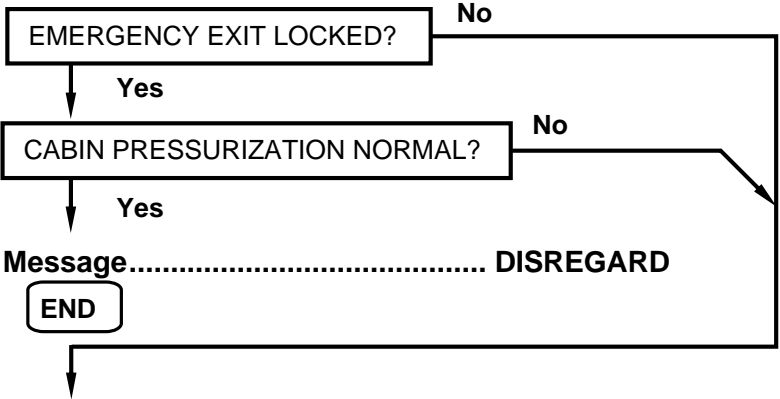

LAND AT THE NEAREST SUITABLE AIRPORT.

Oxygen Masks AS REQUIRED

Altitude MEA OR 10'000 FT,
WHICHEVER IS HIGHER

When reaching 10'000 ft:

Cabin DEPRESSURIZE

END

User: aherrera - Printed By myTechCare - Jul 25/22 - 13:50:24

EMERGENCY/ABNORMAL PROCEDURES

Doors

INTENTIONALLY BLANK

User: aherrera - Printed By myTechCare - Jul 25/22 - 13:50:24

TABLE OF CONTENTS

ANNUNCIATED PROCEDURES

BATTERY OVERTEMPERATURE	EAP 5-3
ELECTRIC ESSENTIAL TRANSFER FAILURE ..	EAP 5-3
LOSS OF ALL GENERATORS	EAP 5-4
SMOKE / FIRE / FUMES.....	refer to S-6
115 V AC BUS OFF	EAP 5-5
APU CONTACTOR CLOSED	refer to EAP 3-4
BACK-UP BATTERY OFF BUS	EAP 5-5
BATTERY OFF BUS	EAP 5-5
DC BUS 1 OFF	EAP 5-6
DC BUS 2 OFF	EAP 5-7
ELECTRICAL EMERGENCY ABNORMAL TRANSFER	EAP 5-8
EMERGENCY LIGHTS NOT ARMED	EAP 5-8
ESSENTIAL BUS 1 OFF	EAP 5-9
ESSENTIAL BUS 2 OFF	EAP 5-10
ESSENTIAL BUS 1-2 OFF	EAP 5-11
GENERATOR OFF BUS	EAP 5-12
GENERATOR OVERLOAD.....	EAP 5-12

ANNEX 01 - AFFECTED EQUIPMENT

DC BUS FAILURE	EAP 5-13
ESS BUS FAILURE	EAP 5-14

User: aherrera - Printed By myTechCare - Jul 25/22 - 13:50:24

EMERGENCY/ABNORMAL PROCEDURES

Electrical & Lighting

LIST OF EICAS MESSAGES

BATT 1 (2) OVTEMP	EAP 5-3
ELEC ESS XFR FAIL.....	EAP 5-3
115 VAC BUS OFF	EAP 5-5
APU CNTOR CLSD	refer to EAP 3-4
APU GEN OFF BUS	EAP 5-12
APU GEN OVLD	EAP 5-12
BKUP BATT OFF BUS	EAP 5-5
BATT1 (2) OFF BUS.....	EAP 5-5
DC BUS 1 OFF	EAP 5-6
DC BUS 2 OFF	EAP 5-7
ELEC EMERG ABNORM.....	EAP 5-8
EMERG LT NOT ARMD.....	EAP 5-8
ESS BUS 1 OFF	EAP 5-9
ESS BUS 2 OFF	EAP 5-10
ESS BUS 1-2 OFF	EAP 5-11
GEN 1-2-3-4 OFF BUS	EAP 5-4
GEN 1 (2, 3, 4) OFF BUS	EAP 5-12
GEN 1 (2, 3, 4) OVLD	EAP 5-12

BATTERY OVERTEMPERATURE

EICAS Warning: BATT 1 (2) OVTEMP

MFD Indication: Battery temperature in red.

Affected Battery OFF

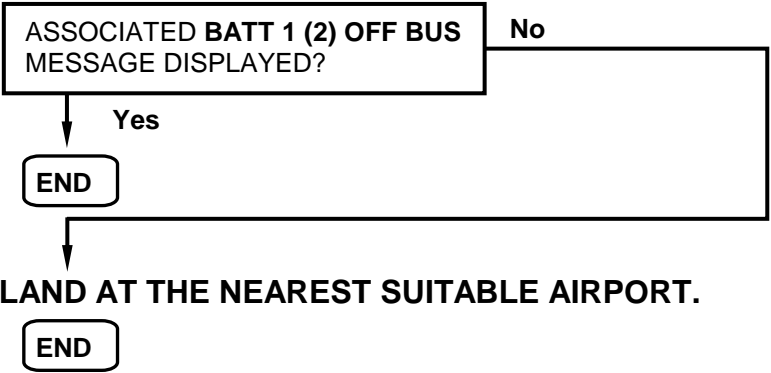

ELECTRIC ESSENTIAL TRANSFER FAILURE

EICAS Warning: ELEC ESS XFR FAIL

If no generator is available:

Essential Power PUSH IN

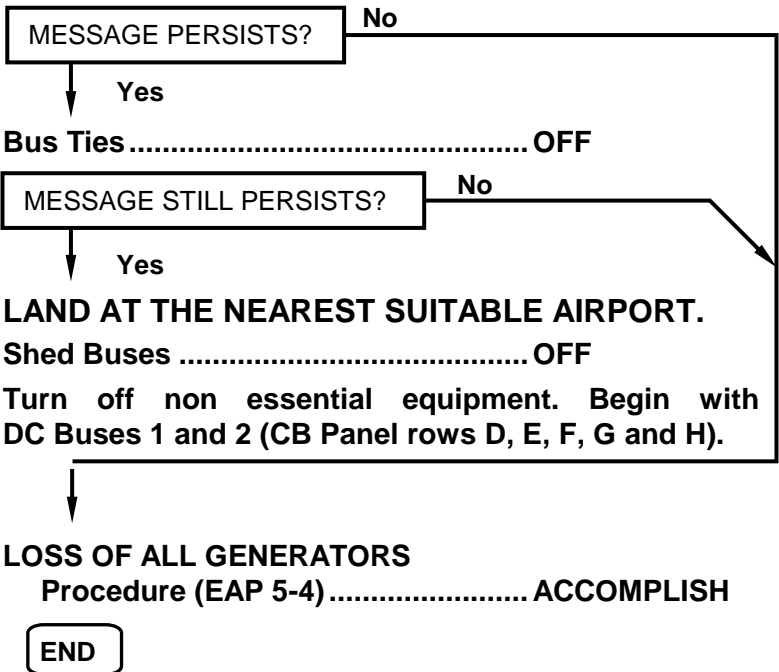

User: aherrera - Printed By myTechCare - Jul 25/22 - 13:50:24

EMERGENCY/ABNORMAL PROCEDURES

Electrical & Lighting

LOSS OF ALL GENERATORS

EICAS Caution: GEN 1-2-3-4 OFF BUS,
APU GEN OFF BUS may be presented.

Condition: Noise increase due to nose landing gear doors open.

Generators..... **PUSH OUT, THEN PUSH IN**

APU **AS REQUIRED**

Remember APU Maximum Start Altitude limitation.

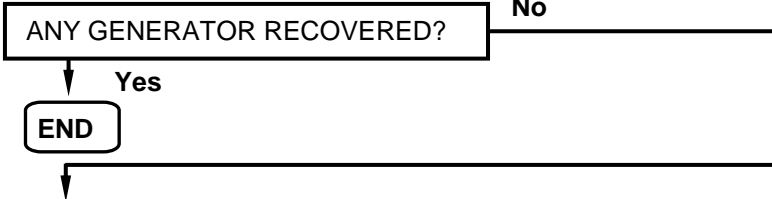

LAND AT THE NEAREST SUITABLE AIRPORT.

CAUTION: MULTIPLY THE FLAPS 45° UNFACTORED LANDING DISTANCE BY 1.95.

Airspeed **MAX 250 KIAS**

Altitude **MEA OR 10'000 FT, WHICHEVER IS HIGHER**

Essential Power **PUSH IN**

Crew Oxygen..... **AS REQUIRED**

Passenger Oxygen..... **AS REQUIRED**

Emerg Lts **OFF**

If required, turn on Emergency Lights before landing.

Icing Conditions..... **EXIT/AVOID**

Use standby instruments and RMU Navigation Backup Page.

CAUTION: BATTERY DURATION IS 40 MINUTES.

Do not set Thrust Levers below idle in flight.

Relevant Inoperative Items:

Autopilot	W/S 1 and 2 Heating and Wiper	GPWS
FMS 1 and 2	Transponder 1 and 2	RA 1
Speed Brake	Main Pitch Trim	TCAS
Pack 1 and 2	Stick Pusher	Steering
Spoilers	ADF/DME/VHF/VOR/ILS/MB 2 and DME 1	Flaps
Ventral Fuel Transfer Pump A and B (EMB-145XR only)		

Affected Equipment (EAP 5-13 and 5-14)..... CHECK

CONTINUES ON NEXT PAGE

EMERGENCY/ABNORMAL PROCEDURES

Electrical & Lighting

CONTINUED FROM PREVIOUS PAGE

Landing configuration:

Landing GearDOWN

If necessary:

LG WRN CutoutPRESS

FLAPS POSITION	MINIMUM AIRSPEED
0 to 8°	V _{REF 45} + 30 KIAS
9° to 21°	V _{REF 45} + 10 KIAS
22° to 44°	V _{REF 45} + 5 KIAS
45°	V _{REF 45}

CAUTION: MULTIPLY THE FLAPS 45° UNFACTORED LANDING DISTANCE BY 1.95.

Do not actuate Thrust Reversers.

END

115 V AC BUS OFF

EICAS Caution: 115 VAC BUS OFF

AC PowerPUSH OUT, THEN PUSH IN

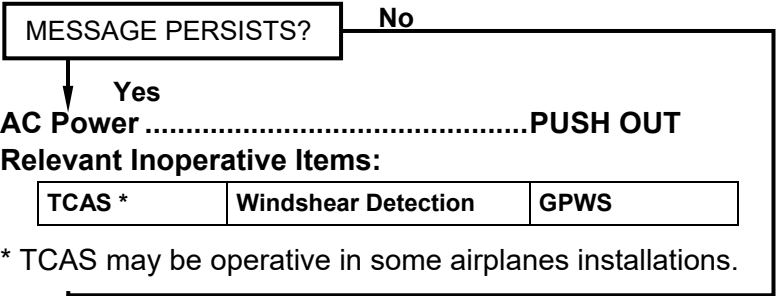

* TCAS may be operative in some airplanes installations.

END

BACK-UP BATTERY OFF BUS

EICAS Caution: BKUP BATT OFF BUS

Backup BatteryCHECK PUSHED IN

END

BATTERY OFF BUS

EICAS Caution: BATT1 (2) OFF BUS

MFD Indication: Battery may be amber.

Affected BatteryAUTO

END

EMERGENCY/ABNORMAL PROCEDURES

Electrical & Lighting

DC BUS 1 OFF

EICAS Caution: DC BUS 1 OFF

MFD Indication: DC BUS may be amber.

Bus TiesOVRD

MESSAGE PERSISTS?

No

Yes

Bus TiesAUTO

AutopilotDISENGAGE

Icing ConditionsEXIT/AVOID

AltitudeMAX 25'000 FT,
MINIMUM MEA

At pilot's discretion:

MFD Knob on

Reversionary Panel 1.....PFD

Relevant Inoperative Items:

Ventral Fuel Transfer Pump A (EMB-145XR only)		
Autopilot	W/S 1 Heating and Wiper	GPWS
FMS 1	Transponder 1	RA 1
Speed Brake	Main Pitch Trim	TCAS *
Automatic Pressurization Control		DME 1
Thrust Reverser 1		Pack 1

* TCAS may be operative in some airplanes installations.

Do not set Thrust Lever 1 below idle in flight.

Affected Equipment (EAP 5-13)CHECK

Landing configuration:

Anticipate flap slower actuation.

Flaps.....22°

V_{REF}.....V_{REF 45°} + 10 KIAS

CAUTION: MULTIPLY THE FLAPS 45° UNFACTORED
LANDING DISTANCE BY 1.50.

Do not actuate Thrust Reverser 1.

END

EMERGENCY/ABNORMAL PROCEDURES

Electrical & Lighting

DC BUS 2 OFF

- EICAS Caution:** DC BUS 2 OFF
- MFD Indication:** DC BUS may be amber.
- MFD Indication:** Noise increase due to nose landing gear doors open.

Bus TiesOVRD

MESSAGE PERSISTS? **No**

Yes

- Bus TiesAUTO**
- Icing ConditionsEXIT/AVOID**
- AirspeedMAX 250 KIAS**
- AltitudeMAX 25'000 FT,
MINIMUM MEA**

The overhead panel lighting is inoperative, therefore, all striped bars will not illuminate.

SG on Reversionary Panel 2PUSH IN

At pilot's discretion:

**MFD Knob on
Reversionary Panel 2PFD**

MFD Control is possible through MFD 1 Bezel.

Relevant Inoperative Items:

Stick Pusher	W/S 2 Heating and Wiper	Steering
FMS 2	Transponder 2	Pack 2
ADF/DME/VHF/VOR/ILS/MB 2		
Thrust Reverser 2		

Do not set Thrust Lever 2 below idle in flight.

Affected Equipment (EAP 5-13)CHECK

Landing configuration:

Anticipate flap slower actuation.

Flaps 22°

V_{REF} V_{REF} 45° + 10 KIAS

CAUTION: MULTIPLY THE FLAPS 45° UNFACTORED LANDING DISTANCE BY 1.50.

Do not actuate Thrust Reverser 2.

END

User: aherrera - Printed By myTechCare - Jul 25/22 - 13:50:24

EMERGENCY/ABNORMAL PROCEDURES

Electrical & Lighting

ELECTRICAL EMERGENCY ABNORMAL TRANSFER

EICAS Caution: ELEC EMERG ABNORM

Essential Power.....**CHECK PUSHED OUT**

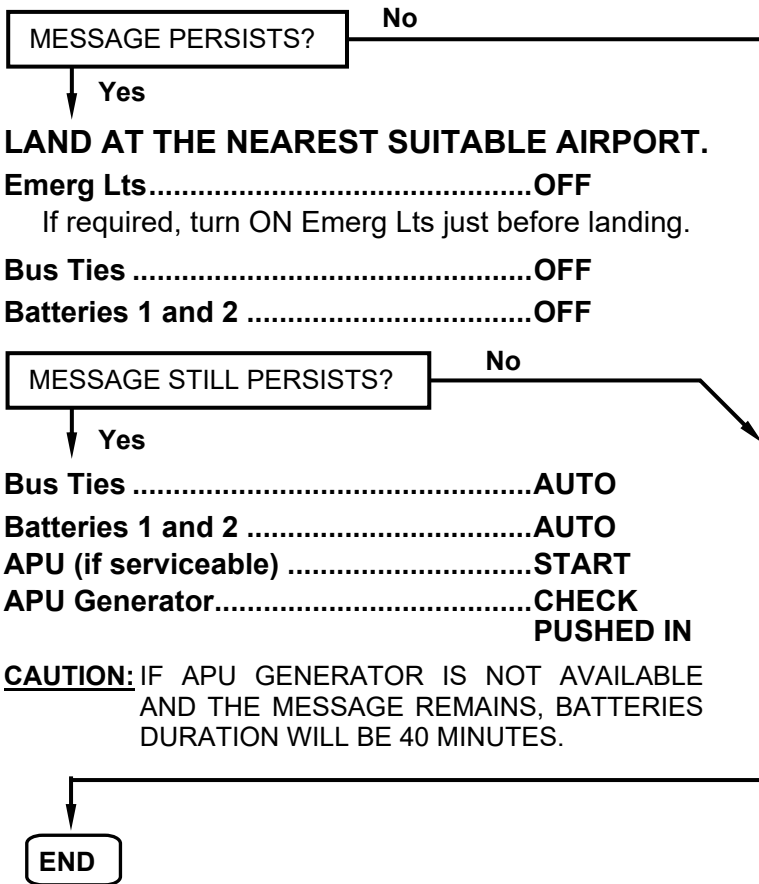

EMERGENCY LIGHTS NOT ARMED

EICAS Caution: EMERG LT NOT ARMD

EMERG LT Switch.....**ARM**

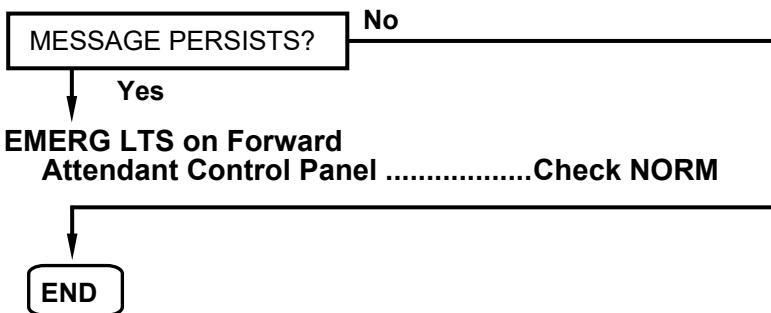

EMERGENCY/ABNORMAL PROCEDURES

Electrical & Lighting

ESSENTIAL BUS 1 OFF

EICAS Caution: ESS BUS 1 OFF

- SG On Reversionary Panel 1.....PUSH IN
- Fuel Pump 1.....1B OR 1C
- Fuel Pump 2.....2A OR 2C
- Altitude.....MAX 25'000 FT,
MIN MEA

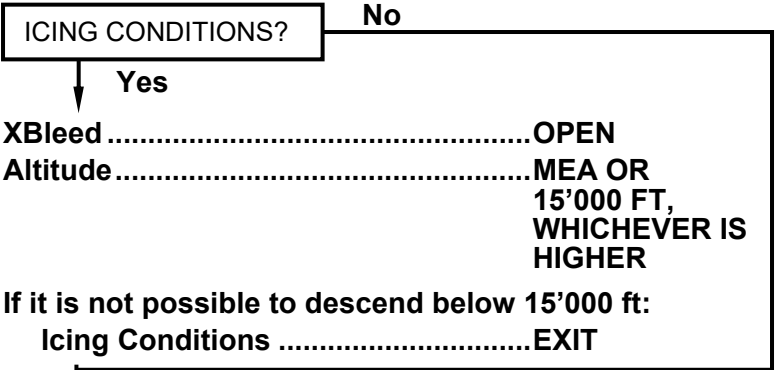

Monitor fuel quantity indication 1 through FMS.
COM 2 on Digital Audio Panel 2.....PUSH IN
Relevant Inoperative Items:

ADF 1/VHF 1/VOR 1/ILS 1/MB 1	Audio System 1
ENG 1 Fire Detection System	RMU 1
Landing Gear Control (Down Override)	

Affected Equipment (EAP 5-14)CHECK

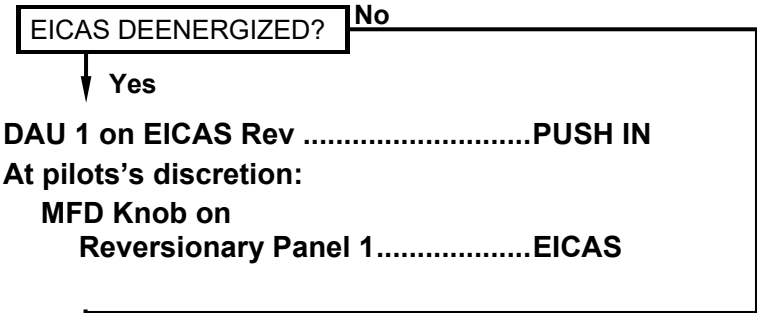

Landing configuration:

- Landing GearDOWN
- Flaps45°
- AirspeedV_{REF 45°}

CAUTION: MULTIPLY THE FLAPS 45° UNFACTORED
LANDING DISTANCE BY 1.45.

Brake effectiveness will be reduced.

END

EMERGENCY/ABNORMAL PROCEDURES

Electrical & Lighting

ESSENTIAL BUS 2 OFF

EICAS Caution: ESS BUS 2 OFF
MFD Indication: ESS BUS may be amber.

Fuel Pump 1 1A OR 1C
Fuel Pump 2 2B OR 2C
Icing Conditions EXIT/AVOID
Altitude MAX 25'000 FT,
MIN MEA

Monitor fuel quantity indication 2 through FMS.

CAUTION: DO NOT USE CROSSFEED.

Relevant Inoperative Items:

ISIS/Standby Altimeter (except for EMB-145XR Model)	
APU Fire Detection System	Pitot Heating 3
ENG 2 Fire Detection System	Standby Attitude Indicator
APU Control	RMU 2
Audio System 2	

Affected Equipment (EAP 5-14) CHECK

When necessary to extend landing gear:

Landing Gear Lever DOWN
Gear Electrical Override DOORS

 WAIT 3 SECONDS
Gear Electrical Override GEAR/DOORS

Landing configuration:

Landing Gear DOWN
Flaps 45°
Airspeed V_{REF} 45°

CAUTION: MULTIPLY THE FLAPS 45° UNFACTORED LANDING DISTANCE BY 1.45.

Brake effectiveness will be reduced.

END

EMERGENCY/ABNORMAL PROCEDURES

Electrical & Lighting

ESSENTIAL BUS 1-2 OFF

EICAS Caution: ESS BUS 1-2 OFF

Bus Ties OFF

MFD Electrical Page CHECK

BOTH DC BUSES ENERGIZED? No

Yes

Battery 1 and 2 OFF

MESSAGE ESS BUS 1 OFF PERSISTS? No

Yes

ESSENTIAL BUS 1 OFF

Procedure (EAP 5-9) ACCOMPLISH

END

MESSAGE ESS BUS 2 OFF PERSISTS? No

Yes

ESSENTIAL BUS 2 OFF

Procedure (EAP 5-10) ACCOMPLISH

END

END

WHICH DC BUS IS ENERGIZED? DC BUS 2

DC BUS 1

Battery 1 OFF

Check which Essential Bus is off.

Associated ESSENTIAL BUS OFF

Procedure (EAP 5-9 or EAP 5-10) ... ACCOMPLISH

END

Battery 2 OFF

Check which Essential Bus is off.

Associated ESSENTIAL BUS OFF

Procedure (EAP 5-9 or EAP 5-10) ... ACCOMPLISH

END

User: aherrera - Printed By myTechCare - Jul 25/22 - 13:50:24

EMERGENCY/ABNORMAL PROCEDURES

Electrical & Lighting

GENERATOR OFF BUS

EICAS Caution: GEN 1 (2, 3, 4) OFF BUS or
APU GEN OFF BUS

MFD Indication: Generator voltage may be amber.

ALL GENERATORS OFF BUS?

No

Yes

LOSS OF ALL GENERATORS

Procedure (EAP 5-4)..... ACCOMPLISH

END

Affected Generator PUSH OUT,
THEN PUSH IN

APU (if serviceable) AS REQUIRED

END

GENERATOR OVERLOAD

EICAS Caution: GEN 1 (2, 3, 4) OVLD or
APU GEN OVLD

MFD Indication: Generator may be amber.

Shed Buses OFF

MESSAGE PERSISTS?

No

Yes

Electrical Load (affected generator).... REDUCE

The equipments that require more electrical load and may be turned OFF, at pilot's discretion, are: lights, hydraulic electric pump, ice protection and air conditioning related systems. Non-required equipment may also be turned OFF.

GEN 1 (2, 3, 4) OVLD EICAS
MESSAGE DISPLAYED?

No

Yes

APU ON?

No

Yes

APU GEN PUSH IN

END

APU START

APU GEN PUSH IN

END

EAP 5-12

REVISION 16

EMERGENCY/ABNORMAL PROCEDURES

Electrical & Lighting

ANNEX 01

In case of electrical bus failure, refer to the following table to verify the affected equipment.

DC BUS 1

AILERON CONTROL SYSTEM 1
AIR/GND POSITION SYSTEM A
AOA 1 SENSOR HEATING
AUTOMATIC PRESSURIZATION CONTROL
AUTOPILOT 1
BRAKES TEMP INDICATION OUTBD
CLEAR ICE DET - CHANNEL 1
CMC
CREW PEDAL ADJUSTMENT
CREW SEAT ADJUSTMENT 1
DME 1
EICAS POWER (DAU 1B)
ELECTRICAL FLIGHT IDLE STOP 1
ELECTRONIC BAY COOLING (EXHAUST 1 AND RECIRC 2)
EMER/PARKING BRAKE
ENG 1 FUEL PUMPS 1C
ENGINE 1 ANTI-ICE
FLAP CHANNEL 1
FMS SYSTEM 1 *
FUEL PRESSURE REFUELING 1/2
GROUND SPOILER OUTBD
HEAD-UP GUIDANCE SYSTEM
HYDR ELECTRIC PUMP 2
HYDR GEN SYS 2 INDICATION
ICE DETECTOR 1
INVERTER
LAVATORY FLUSH
LAVATORY SMOKE DETECTOR
LAVATORY WATER DRAIN HEATER
LIGHTING: CABIN 1, OVERHEAD PANEL, COCKPIT READING, COURTESY/STAIR 2, FLOOD/STORM, LAVATORY, LOGOTYPE
LIGHTS: LANDING 1 & NAVIGATION
MAIN DOOR CONTROL 1
MFD 2 POWER
PACK VALVE 1
PASSENGER SIGNS
PFD 1 POWER
PITCH TRIM MAIN
PITOT 1 HEATING
PNEUMATIC HSV 1
PUMP A (EMB-145XR)
RADAR SYSTEM
RADIO ALTIMETER 1
SPEED BRAKE
STATIC PORT HEATING 1
STROBE LIGHTS
TAT 1 SENSOR HEATING
TCAS 2000
TRANSPONDER 1
VHF SYSTEM 3 *
WINDSHIELD HEATING 1
WINDSHIELD WIPER 1
WING ANTI-ICE
YAW TRIM

DC BUS 2

ADC 2
ADF 2 *
AHRS 2 or IRS 2
AILERON CONTROL SYSTEM 2
AIR/GND POSITION SYSTEM C
AOA 2 SENSOR HEATING
AURAL WARNING SYSTEM 2
BAGGAGE SMOKE DETECTOR
BRAKES TEMP INDICATION INBD
CABIN RECIRCULATION
CLEAR ICE DET - CHANNEL 2
CLOCK COPILOT'S
CREW SEAT ADJUSTMENT 2
DEFUELING
DISPLAY PRCS/CTRL PWR 2 (IC 2)
DME 2
EICAS POWER (DAU 2B)
ELECTRICAL FLIGHT IDLE STOP 2
ELECTRONIC BAY COOLING (EXHAUST 2 AND RECIRC 1)
ENG 2 FUEL PUMPS 2C
ENGINE VIBRATION SENSORS
ENGINE 2 ANTI-ICE
FLAP CHANNEL 2
FMS SYSTEM 2 *
GASPER FAN
GPS *
GROUND SPOILER INBD
GUST LOCK (ELECTROMECHANICAL)
HF POWER/CONTROL *
HYDR ELECTRIC PUMP 1
HYDR GEN SYS 1 INDICATION
ICE DETECTOR 2
IRS 2
LANDING GEAR DOOR COMMAND
LIGHTING: OVERHEAD PANEL, COMPARTMENT, INSPECTION & PASSENGER CABIN 1/2/3
LIGHTS: RED BEACON & LANDING
MFD 1 POWER
OBSERVER'S DAP (INTPH 3)
PACK VALVE 2
PFD 2 POWER
PITOT 2 HEATING
PNEUMATIC HSV 2
PUMP B (EMB-145XR)
RADIO ALTIMETER 2 *
ROLL TRIM SYSTEM
SENSORS HEATING CONTROL
SPOILER INDICATION
SPS (SHAKER 2/CHANNEL 2)
SPS PUSHER
STABILIZER ANTI-ICE
STATIC PORT HEATING 2
STEERING
TAT 2 SENSOR HEATING
TRANSPONDER 2
TUNING BACKUP CONTROL HEAD
VHF SYSTEM 2
VOR 2/ILS 2/MB 2
WINDSHIELD WIPER 2

Optional equipments are marked with an asterisk (*)

REVISION 17

EAP 5-13

EMERGENCY/ABNORMAL PROCEDURES

Electrical & Lighting

ANNEX 01

In case of electrical bus failure, refer to the following table to verify the affected equipment.

ESSENTIAL BUS 1

ADC 1
ADF 1
AHRs 1
AIR/GND POSITION SYSTEM B
APU BLEED
AURAL WARNING SYSTEM 1
BRAKES OUTBOARD
CLOCK PILOT'S
DISPLAY PRCS/CTRL PWR 1 (IC 1)
EICAS (DAU 1A)
EICAS DISPLAY
ENG 1 FIRE DETECTION
ENG 1 FUEL PUMPS 1A
ENG 2 FUEL PUMPS 2B
ENGINE 1 STARTING
ENGINES N2 SIGNALS 1A AND 2A
ENGINES 1 AND 2 FADEC A
FDR MANAGEMENT
FUEL QUANTITY INDICATION 1
IRS 1
LDG CONTROL (DOWN OVRD)
LDG NOSE INDICATION 1
LIGHTS COCKPIT DOME
PANEL LIGHTING PILOT'S
PASSENGER OXYGEN SYSTEM 1
PILOT/COPILOT'S DAP (INTPH 1)
PNEUMATIC 1 (EBV 1)
RAM AIR DISTRIBUTION
RMU 1
RUDDER CONTROL SYSTEM 2
SPS (SHAKER 1/CHANNEL 1)
VHF SYSTEM 1
VOR/ILS/MB 1

ESSENTIAL BUS 2

AIR/GND POSITION SYSTEM D
APU CONTROL
APU FIRE DETECTION
APU FIRE EXTINGUISHING
APU FUEL FEED
BRAKES INBOARD
CROSSBLEED
EICAS (DAU 2A)
ENG 1 FUEL PUMPS 1B
ENG 2 FIRE DETECTION
ENG 2 FUEL PUMPS 2A
ENGINE 2 STARTING
ENGINES N2 SIGNALS 1B AND 2B
ENGINES 1 AND 2 FADEC B
FUEL CROSS FEED
FUEL QUANTITY INDICATION 2
ISIS (all models except for
EMB-145XR)
LDG CONTROL
LDG NOSE INDICATION 2
LIGHTING EMERGENCY CTRL
LIGHTING PANEL COPILOT'S AND
PEDESTAL
PASSENGER OXYGEN SYSTEM 2
PILOT/COPILOT'S DAP (INTPH 2)
PITCH TRIM BACKUP
PITOT HEATING 3
PNEUMATIC 2 (EBV 2)
PUBLIC ADDRESS
RMU 2
RUDDER CONTROL SYSTEM 1
STANDBY ALTIMETER
STANDBY ATTITUDE INDICATOR
VOICE RECORDER

TABLE OF CONTENTS
ANNUNCIATED PROCEDURES

ATTCS FAILURE EAP 6-3

BLEED ENGINE LEAK..... refer to EAP 1-4

DUAL ENGINE FAILURE..... EAP 6-3

ENGINE ATTCS NO MARGIN EAP 6-5

ENGINE FIRE, SEVERE DAMAGE OR SEPARATION EAP 6-6

ENGINE OIL LOW PRESSURE..... EAP 6-7

ENGINE ANTI-ICING FAILURE refer to EAP 11-5

ENGINE ATS SHUTOFF VALVE OPEN EAP 6-8

ENGINE CONTROL FAILURE..... EAP 6-9

ENGINE FUEL FILTER IMPENDING BYPASS... EAP 6-9

ENGINE FUEL LOW PRESSURE..... refer to EAP 9-5

ENGINE FUEL LOW TEMPERATURE .. refer to EAP 9-5

ENGINE FUEL SHUTOFF VALVE INOPERATIVE refer to EAP 9-6

ENGINE IDLE STOP FAILURE..... EAP 6-9

ENGINE OUT..... EAP 6-10

ENGINE THRUST LEVER FAILURE EAP 6-11

ENGINE THRUST REVERSER FAILURE/DISAGREE EAP 6-12

NON ANNUNCIATED PROCEDURES

ABNORMAL ENGINE START refer to NAP-12

ENGINE ABNORMAL VIBRATION refer to NAP-15

ENGINE AIRSTART..... refer to NAP-16

ENGINE FAILURE/SHUTDOWN refer to NAP-19

ENGINE HIGH OIL PRESSURE refer to NAP-20

ENGINE HIGH OIL TEMPERATURE..... refer to NAP-20

ENGINE LOW OIL LEVEL refer to NAP-20

ENGINE LOW OIL PRESSURE..... refer to NAP-21

ENGINE OVERTEMPERATURE refer to NAP-21

LOSS OF ENGINE INDICATIONS..... refer to NAP-26

ONE ENGINE INOPERATIVE APPROACH AND LANDING refer to NAP-30

SINGLE ENGINE BLEED OPERATION IN ICING CONDITIONS refer to NAP-34

EMERGENCY/ABNORMAL PROCEDURES

Engine

LIST OF EICAS MESSAGES

ATTCS FAIL	EAP 6-3
BLD 1 (2) LEAK	refer to EAP 1-4
E1 (2) ATTCS NO MRGN	EAP 6-5
E1 (2) OIL LOW PRESS	EAP 6-7
ENG 1 (2) FIRE	EAP 6-6
ENG 1-2 OUT	EAP 6-3
E1 (2) ATS SOV OPN	EAP 6-8
E1 (2) CTL FAIL	EAP 6-9
E1 (2) FUEL SOV INOP	refer to EAP 9-6
ENG1 (2) OUT	EAP 6-10
ENG1 (2) REV DISAGREE	EAP 6-12
ENG1 (2) REV FAIL	EAP 6-12
ENG1 (2) TLA FAIL	EAP 6-11
E1 (2) FUEL IMP BYP	EAP 6-9
E1 (2) IDL STP FAIL	EAP 6-9

ATTCS FAILURE

EICAS Warning: ATTCS FAIL

Thrust Levers MAX

Another takeoff is not permitted.

END

DUAL ENGINE FAILURE

EICAS Warning: ENG 1-2 OUT may be presented.

Airspeed MIN 260 KIAS
Oxygen Mask AS REQUIRED

Altitude MAX 25'000 FT
Fuel Pumps Selectors 1 and 2 CHECK A or B
Fuel Pumps Pwr 1 and 2 CHECK ON

APU SERVICEABLE?

No

Yes

Thrust Levers IDLE
Engine 1 and 2 Start/Stop Selectors... STOP
APU Bleed PUSH IN
Engine Bleeds 1 and 2 PUSH OUT
Below 25'000 ft:
Engine 1 Start/Stop Selector START, THEN RUN

ENGINE 1 STARTS?

No

Yes

Do not alternate FADEC 1.
ENGINE 2 AIRSTART
Procedure (NAP-16) ACCOMPLISH

END

Engine 1 Start/Stop Selector STOP
Engine 2 Start/Stop Selector START, THEN RUN

CONTINUES ON NEXT PAGE

User: aherrera - Printed By myTechCare - Jul 25/22 - 13:50:24

EMERGENCY/ABNORMAL PROCEDURES

Engine

CONTINUED FROM PREVIOUS PAGE

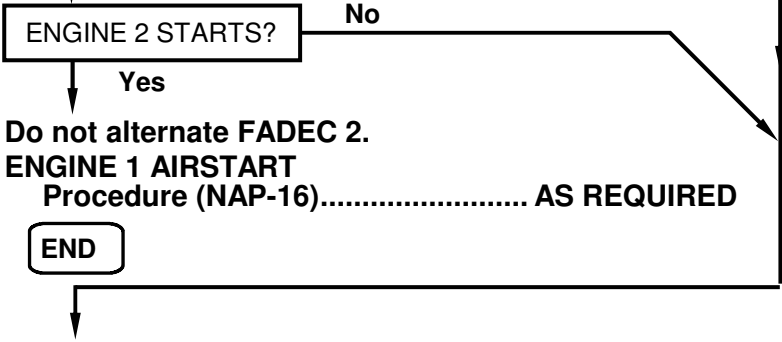

NOTE: Windmilling starts can be attempted in both engines simultaneously.

Airspeed **MIN 260 KIAS**

Minimum N2 **10%**

Initiate windmilling start with N2 as high as possible.
Once N2 is below 10%, it may not be recovered.

Thrust Levers **IDLE**

Engine 1 and 2 Start/Stop Selectors... **STOP**

Engine 1 and 2 Start/Stop Selectors... **START, THEN RUN**

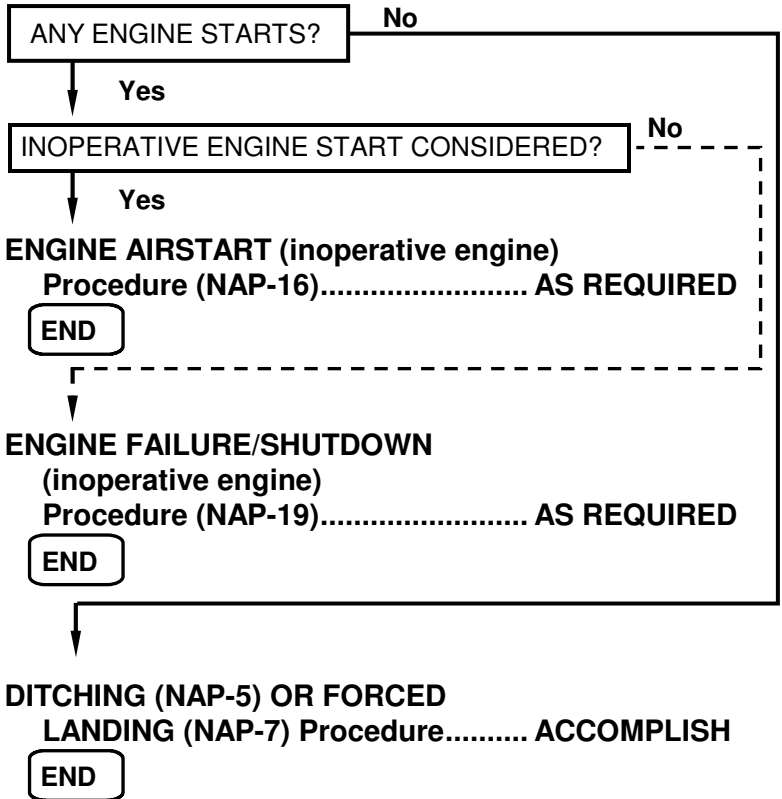

ENGINE ATTCS NO MARGIN

EICAS Warning: E1 (2) ATTCS NO MRGN

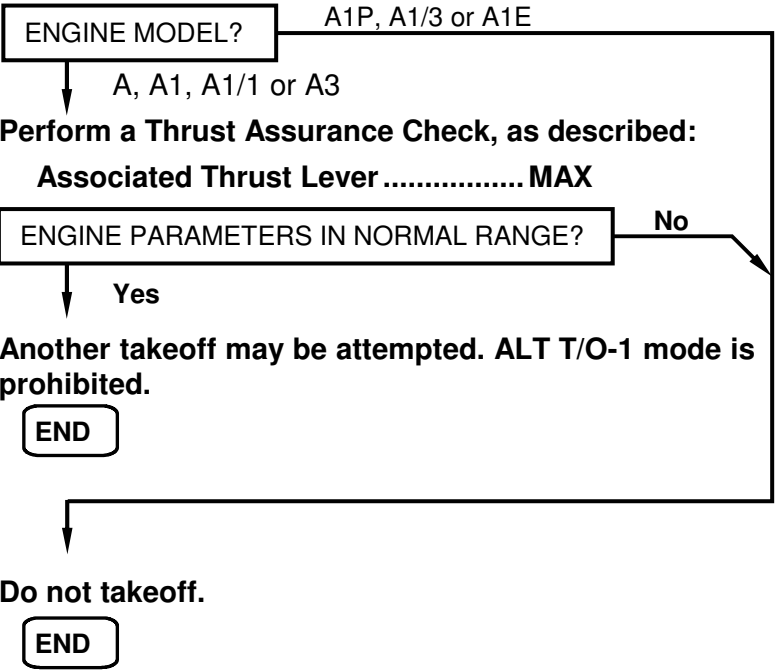

User: aherrera - Printed By myTechCare - Jul 25/22 - 13:50:24

EMERGENCY/ABNORMAL PROCEDURES

Engine

ENGINE FIRE, SEVERE DAMAGE OR SEPARATION

- EICAS Warning:** ENG 1 (2) FIRE (in case of fire) (may be presented)
- Light:** Engine Fire Handle (may be illuminated)
- Aural Warning:** BELL (in case of fire) (may sound)

Associated Thrust Lever IDLE
Associated Start/Stop Selector STOP
Associated Fire Extinguishing Handle PULL (DO NOT ROTATE)

LAND AT THE NEAREST SUITABLE AIRPORT.

E1 (2) FUEL SOV CLSD MESSAGE? **Displayed**

Not Displayed

XFeed Selector Knob OFF
Associated Fuel Pumps OFF

 **WAIT 30 SECS**
Fire Extinguishing Handle (1st shot) ... ROTATE

 **WAIT 30 SECS**

FIRE PERSISTS? **No**

Yes

Fire Extinguishing Handle (2nd shot) .. ROTATE

CONDITION? **On Ground**

In Flight

TCAS TA ONLY
Affected Bleed PUSH OUT

CONTINUES ON NEXT PAGE

User: aherrera - Printed By myTechCare - Jul 25/22 - 13:50:24

EMERGENCY/ABNORMAL PROCEDURES

Engine

CONTINUED FROM PREVIOUS PAGE

Remaining Engine Thrust Rating CON
APU START
APU Bleed AS REQUIRED
XBleed AS REQUIRED

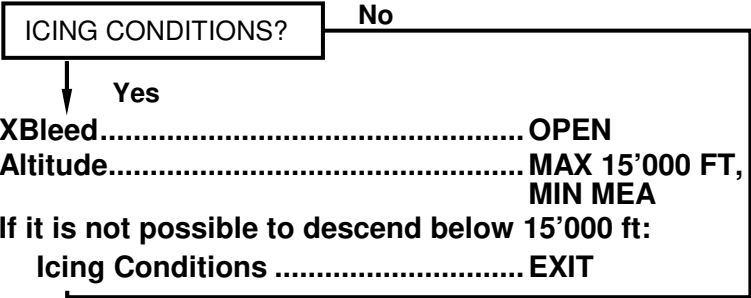

For CAT III or CAT II approaches using HGS, the normal CAT III approach procedure must be used.

Approach:

Altimeters SET AND
CROSS
CHECKED

Approach Aids SET AND
CROSS
CHECKED

Speed Bugs SET

Pressurization CHECK

Go-Around Procedure REVIEW

- Disengage Autopilot.
- Press Go-Around Button.
- Advance Operative Engine Thrust Lever to MAX.
- Rotate airplane to 10° nose up.
- Set flaps to 9°.

With positive rate of climb:

- Landing gear up.
- Maintain Approach Climb Speed until reaching acceleration altitude (level off).

Before Landing:

Inoperative Engine Thrust Lever IDLE
Landing Gear DOWN
Thrust Rating TAKEOFF MODE
Fuel XFeed OFF
Autopilot/Yaw Damper DISENGAGE

Landing configuration:

Flaps 22°
V_{REF} V_{REF45} + 10 KIAS

CAUTION: MULTIPLY THE FLAPS 45° UNFACTORED LANDING DISTANCE BY 1.48.

EMERGENCY EVACUATION

Procedure (NAP-6) AS REQUIRED

END

REVISION 14

EAP 6-6A

EMERGENCY/ABNORMAL PROCEDURES

Engine

INTENTIONALLY BLANK

ENGINE OIL LOW PRESSURE

EICAS Warning: E1 (2) OIL LOW PRESS may be presented.

EICAS Indication: Oil pressure may be red.

Associated Thrust Lever..... REDUCE

Reduce Thrust Lever to at least N2 below 88%, until pressure is within limits.

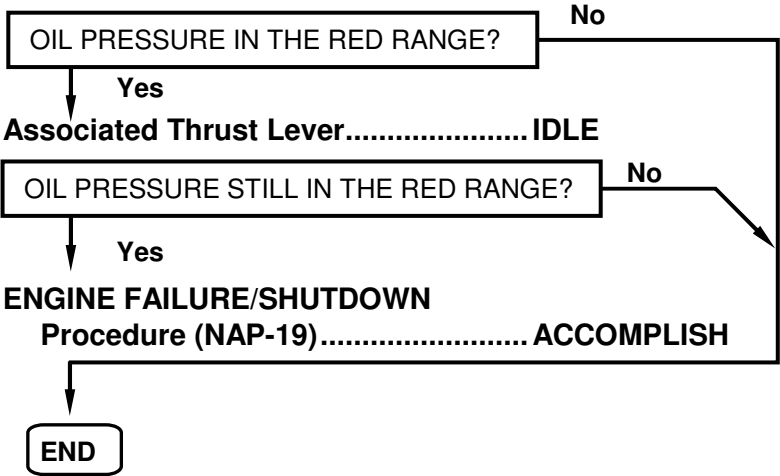

User: aherrera - Printed By myTechCare - Jul 25/22 - 13:50:24

EMERGENCY/ABNORMAL PROCEDURES

Engine

ENGINE ATS SHUTOFF VALVE OPEN

EICAS Caution: E1 (2) ATS SOV OPN

Associated Bleeds

(including APU bleed) PUSH OUT
XBleed CLOSE

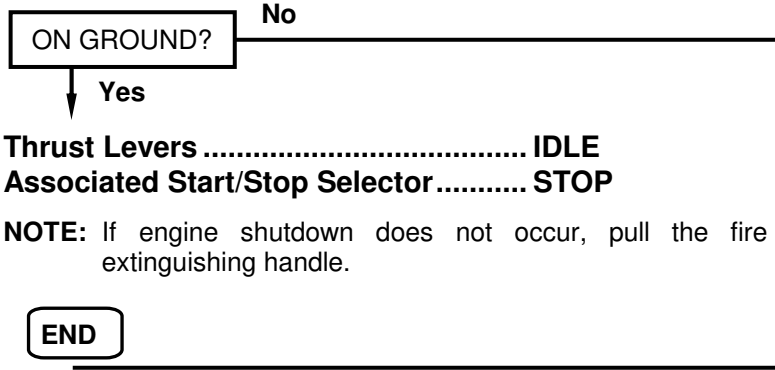

Altitude MAX 25'000 FT,
MIN MEA

Icing Conditions EXIT/AVOID

END

EMERGENCY/ABNORMAL PROCEDURES

Engine

ENGINE CONTROL FAILURE

EICAS Caution: E1 (2) CTL FAIL may be presented.

CAUTION: DO NOT MANUALLY ALTERNATE ASSOCIATED FADECS.

FADEC In Control..... **CHECK**
Associated FADEC..... **RESET**

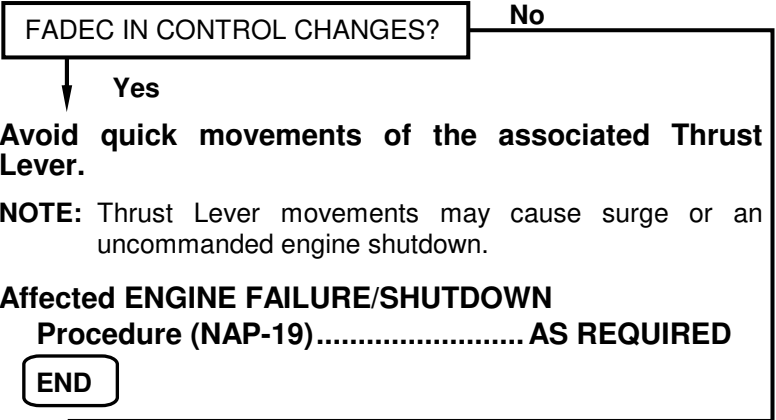

Engine control recovered.

END

ENGINE FUEL FILTER IMPENDING BYPASS

EICAS Advisory: E1 (2) FUEL IMP BYP

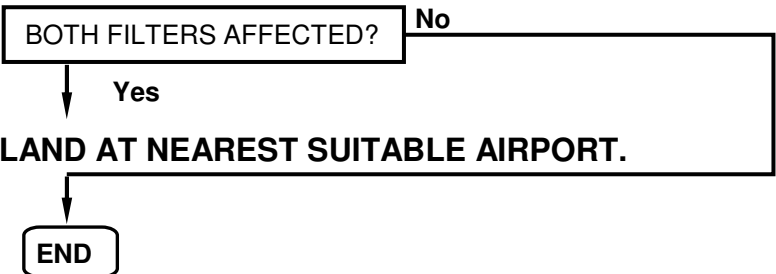

ENGINE IDLE STOP FAILURE

EICAS Advisory: E1 (2) IDL STP FAIL

Protection against thrust lever movement below flight idle is not available.

CAUTION: NEVER SET THRUST LEVER BELOW IDLE INFLIGHT.

END

EMERGENCY/ABNORMAL PROCEDURES

Engine

ENGINE OUT

EICAS Caution: ENG1 (2) OUT

Associated Thrust Lever IDLE
Associated Start/Stop Selector STOP

NOTE: If engine shutdown does not occur, pull the associated fire extinguishing handle.

Engine Thrust Rating CON
APU (if available) START
APU Bleed AS REQUIRED
XBleed AS REQUIRED
Fuel BALANCE

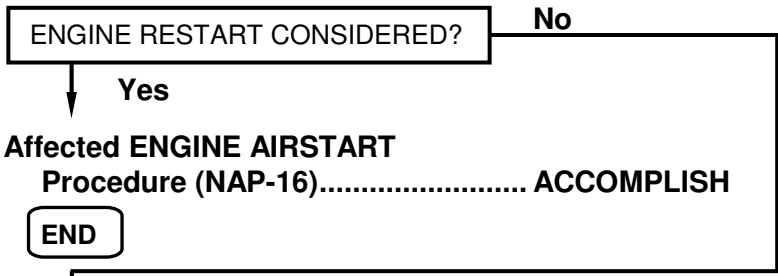

LAND AT THE NEAREST SUITABLE AIRPORT.
TCAS TA ONLY
XBleed OPEN
Altitude MAX 25'000 FT, MIN MEA

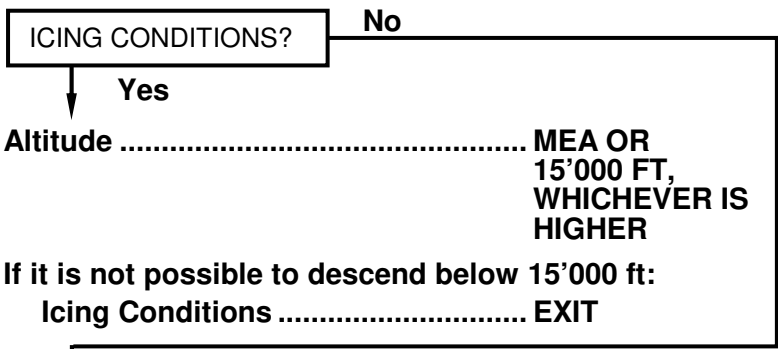

ONE ENGINE INOPERATIVE APPROACH AND LANDING
Procedure (NAP-30) AS REQUIRED

END

User: aherrera - Printed By myTechCare - Jul 25/22 - 13:50:24

ENGINE THRUST LEVER FAILURE

EICAS Caution: ENG1 (2) TLA FAIL

Associated FADEC RESET

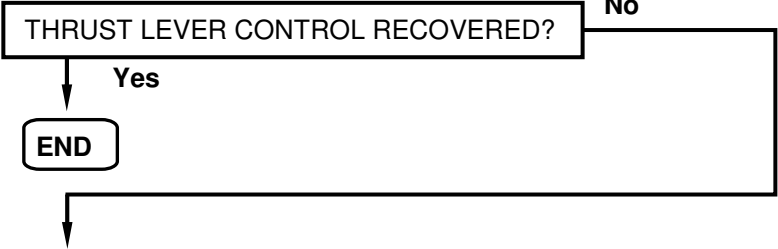

Associated FADEC ALTN

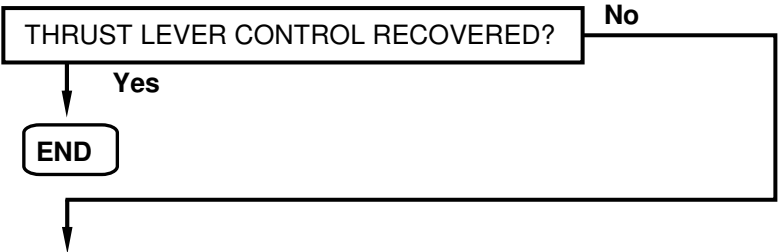

Thrust can be partially controlled through the Thrust Rating Buttons.

Affected ENGINE FAILURE/SHUTDOWN

Procedure (NAP-19) AS REQUIRED



User: aherrera - Printed By myTechCare - Jul 25/22 - 13:50:24

EMERGENCY/ABNORMAL PROCEDURES

Engine

ENGINE THRUST REVERSER FAILURE/DISAGREE

EICAS Caution: ENG1 (2) REV DISAGREE or
 ENG1 (2) REV FAIL

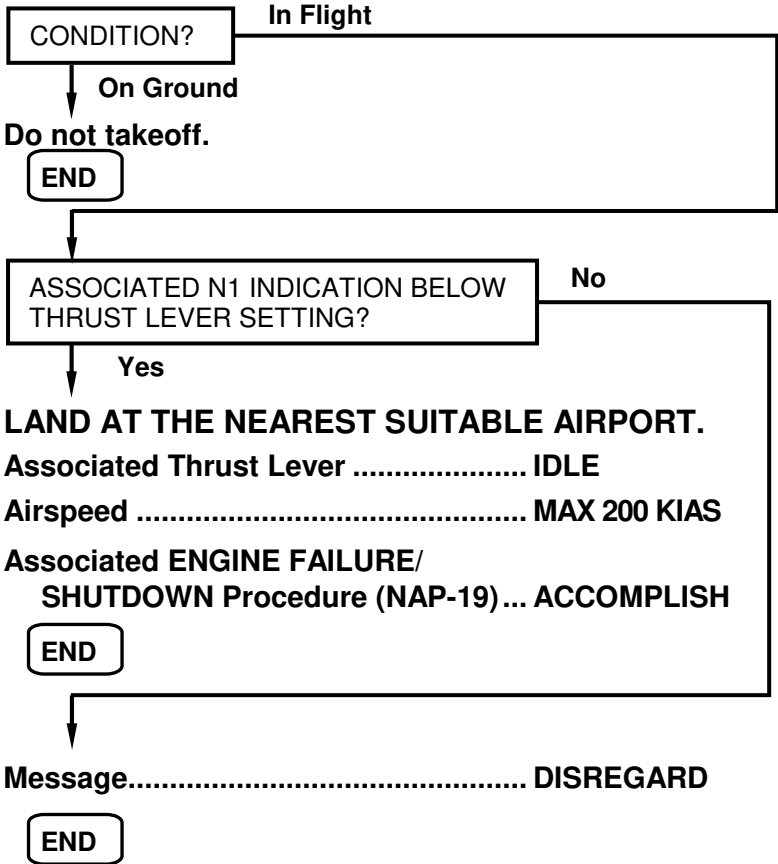

User: aherrera - Printed By myTechCare - Jul 25/22 - 13:50:24

TABLE OF CONTENTS
ANNUNCIATED PROCEDURES

BAGGAGE SMOKE	refer to S-3
ENGINE FIRE, SEVERE DAMAGE OR SEPARATION	refer to EAP 6-6
SMOKE / FIRE / FUMES.....	refer to S-6
APU FIRE DETECTION FAILURE	EAP 7-3
APU FIRE EXTINGUISHING INOPERATIVE.....	EAP 7-3
BAGGAGE COMPARTMENT FIRE EXTINGUISHING INOPERATIVE	EAP 7-4
ENGINE FIRE DETECTION FAILURE.....	EAP 7-4
ENGINE FIRE EXTINGUISHING INOPERATIVE	EAP 7-5

User: aherrera - Printed By myTechCare - Jul 25/22 - 13:50:24

EMERGENCY/ABNORMAL PROCEDURES

Fire Protection

LIST OF EICAS MESSAGES

BAGG SMOKE	refer to S-3
ENG 1 (2) FIRE	refer to EAP 6-6
APU FIREDET FAIL.....	EAP 7-3
APU EXTBTL INOP	EAP 7-3
BAGG EXTBTL INOP	EAP 7-4
E1 (2) FIREDET FAIL	EAP 7-4
E1 (2) EXTBTLA INOP	EAP 7-5
E1 (2) EXTBTLB INOP	EAP 7-5

User: aherrera - Printed By myTechCare - Jul 25/22 - 13:50:24

APU FIRE DETECTION FAILURE

EICAS Caution: APU FIREDET FAIL

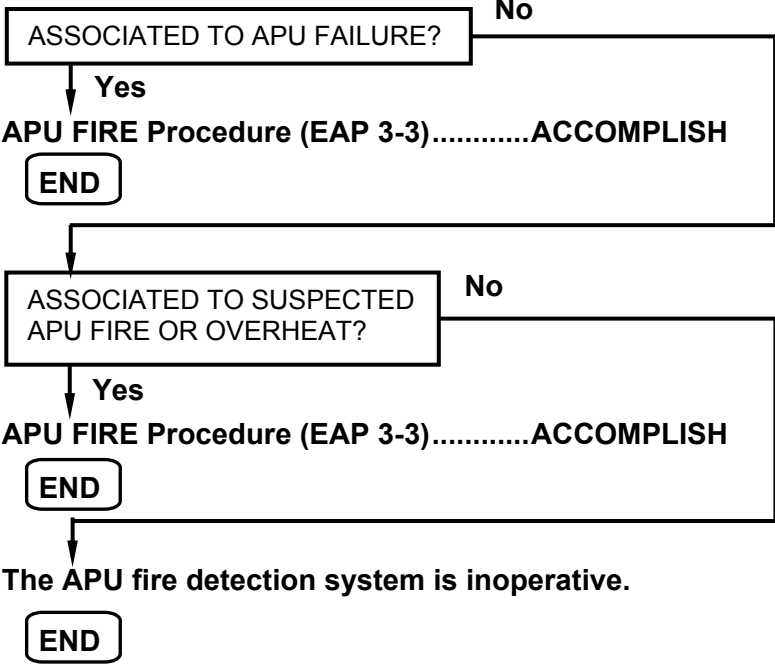

APU FIRE EXTINGUISHING INOPERATIVE

EICAS Caution: APU EXBTBL INOP

Condition: Affected bottle has not been discharged intentionally.

**APU fire protection is not available.
Consider shutting the APU down.**

END

User: aherrera - Printed By myTechCare - Jul 25/22 - 13:50:24

EMERGENCY/ABNORMAL PROCEDURES

Fire Protection

BAGGAGE COMPARTMENT FIRE EXTINGUISHING INOPERATIVE

EICAS Caution: BAGG EXTBTL INOP (if installed).
Condition: Affected bottle has not been discharged intentionally.

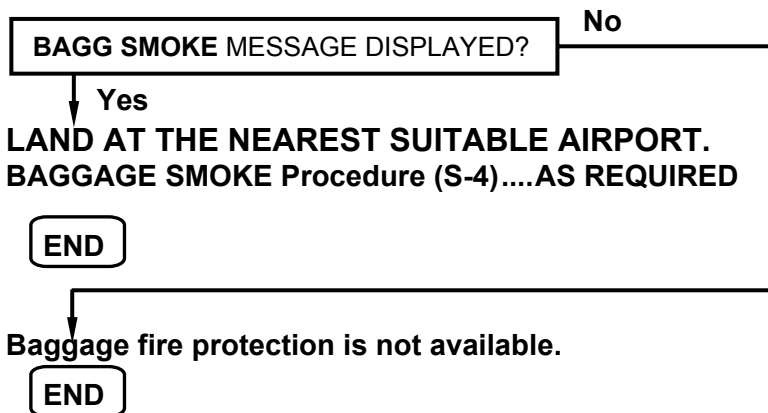

ENGINE FIRE DETECTION FAILURE

EICAS Caution: E1 (2) FIREDET FAIL

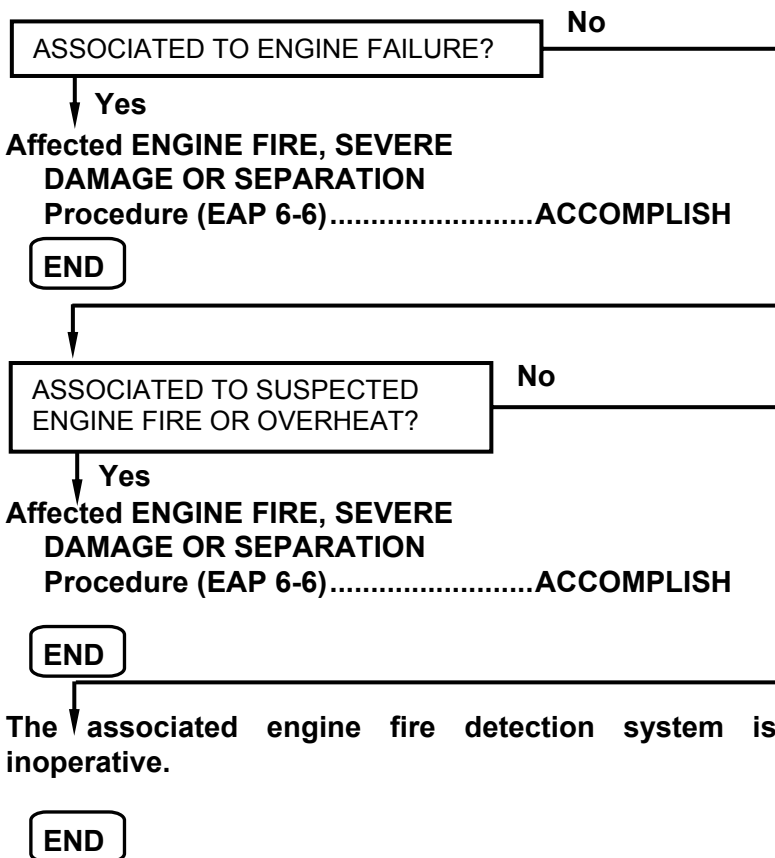

**ENGINE FIRE EXTINGUISHING
INOPERATIVE**

EICAS Caution: E1 (2) EXBTBLA INOP or
E1 (2) EXBTBLB INOP

Condition: Affected bottle has not been
discharged intentionally.

**Only one bottle is available to protect both engines
against fire.**

END

User: aherrera - Printed By myTechCare - Jul 25/22 - 13:50:24

EMERGENCY/ABNORMAL PROCEDURES

Fire Protection

INTENTIONALLY BLANK

TABLE OF CONTENTS ANNUNCIATED PROCEDURES

INADVERTENT SPOILER OPEN	EAP 8-3
PITCH TRIM INOPERATIVE	EAP 8-4
AILERON SYSTEM INOPERATIVE	EAP 8-6
FLAP FAILURE	EAP 8-7
FLAP LOW ACTUATION SPEED	EAP 8-8
PITCH TRIM SWITCH INOPERATIVE.....	EAP 8-8
RUDDER HARDOVER PROTECTION FAILURE	EAP 8-8
RUDDER OVERBOOST	EAP 8-9
RUDDER SYSTEM INOPERATIVE	EAP 8-10
SPEED BRAKE LEVER DISAGREE	EAP 8-11

NON ANNUNCIATED PROCEDURES

AILERON RUNAWAY	refer to NAP-3
JAMMED AILERON	refer to NAP-8A
JAMMED ELEVATOR	refer to NAP-8A
JAMMED RUDDER.....	refer to NAP-9
PITCH TRIM RUNAWAY	refer to NAP-10
ROLL TRIM RUNAWAY.....	refer to NAP-3
AILERON ARTIFICIAL FEEL INOPERATIVE	refer to NAP-14
ASYMMETRIC RUDDER OPERATION .	refer to NAP-14
RUDDER ARTIFICIAL FEEL INOPERATIVE	refer to NAP-33
RUDDER RUNAWAY	refer to NAP-33
STIFFENED ELEVATOR	refer to NAP-35
UNCOMMANDED AILERON DISCONNECTION	refer to NAP-36
UNCOMMANDED ELEVATOR DISCONNECTION	refer to NAP-36
YAW TRIM RUNAWAY.....	refer to NAP-33

User: aherrera - Printed By myTechCare - Jul 25/22 - 13:50:24

EMERGENCY/ABNORMAL PROCEDURES

Flight Controls

LIST OF EICAS MESSAGES

SPOILER FAIL.....	EAP 8-3
PIT TRIM 1 (2) INOP	EAP 8-4
PTRIM MAIN INOP	EAP 8-4
PTRIM BACKUP INOP	EAP 8-4
AIL SYS 1 (2) INOP	EAP 8-6
FLAP FAIL	EAP 8-7
PTRIM CPT SW FAIL	EAP 8-8
PTRIM F/O SW FAIL	EAP 8-8
PTRIM BKP SW FAIL	EAP 8-8
RUD HDOV PROTFAIL	EAP 8-8
RUDDER OVERBOOST	EAP 8-9
RUDDER SYS 1 (2) INOP	EAP 8-10
SPBK LVR DISAGREE	EAP 8-11
FLAP LOW SPEED	EAP 8-8

INADVERTENT SPOILER OPEN

EICAS Caution: SPOILER FAIL (may be presented)
Condition: Sudden airspeed or altitude loss, buffeting or roll tendency.

EICAS Indication: SPLRS OPN

Speed Brake CLOSE

Spoilers CB's F13, F14 and F21 PULL

Do not reduce Thrust during flare.

Landing Configuration:

Flaps 22°

V_{REF45} V_{REF45} + 10 KIAS

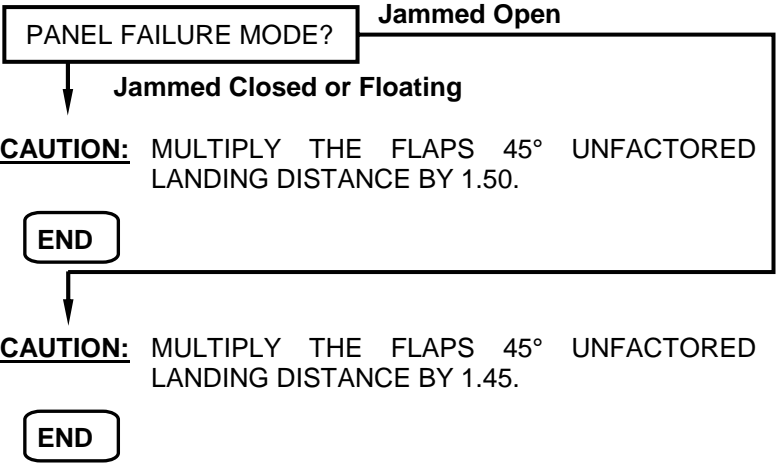

User: aherrera - Printed By myTechCare - Jul 25/22 - 13:50:24

EMERGENCY/ABNORMAL PROCEDURES

Flight Controls

PITCH TRIM INOPERATIVE

EICAS Warning: PTRIM MAIN INOP (may be presented) and/or PTRIM BACKUP INOP (may be presented) or PIT TRIM 1 (2) INOP (may be presented).

EICAS Caution: AUTO TRIM FAIL (may be presented).

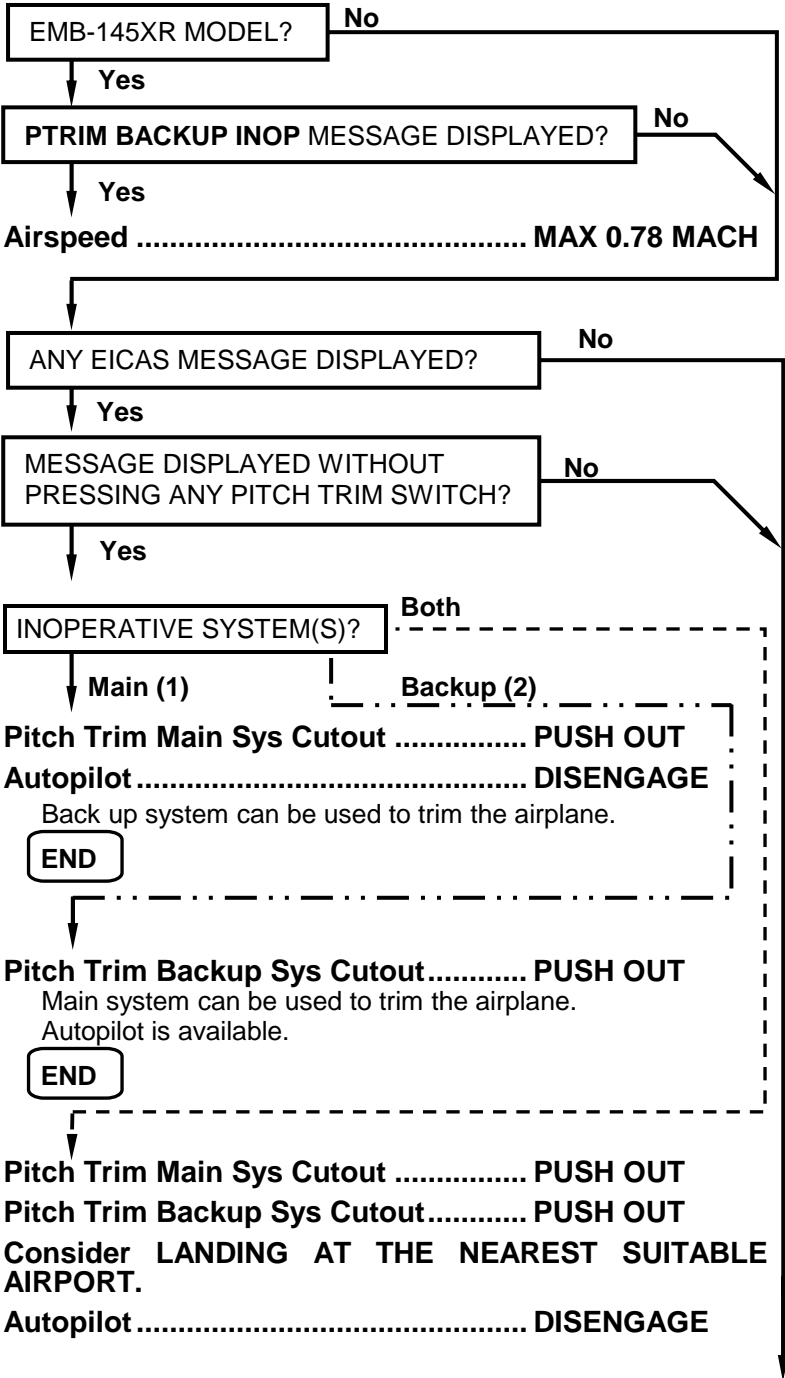

CONTINUES ON NEXT PAGE

User: aherrera - Printed By myTechCare - Jul 25/22 - 13:50:24

EMERGENCY/ABNORMAL PROCEDURES

Flight Controls

CONTINUED FROM PREVIOUS PAGE

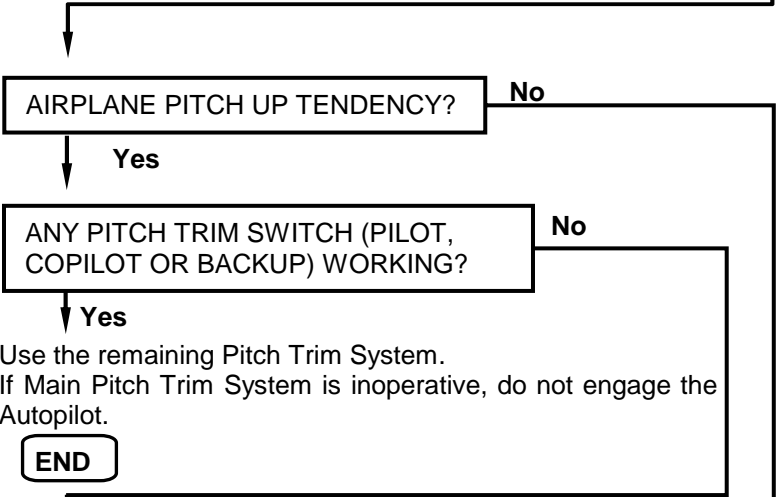

WARNING: DO NOT OPEN SPEEDBRAKE.

Airspeed..... REDUCE

Reduce airspeed to alleviate forward control column forces, observing Flap Maneuvering Speed (PD-2). Continuous turns also helps to alleviate forward control column forces. Extending flaps and landing gear helps to recover trimmed condition.

Landing Configuration:

Landing Gear DOWN

Flaps 22°

V_{REF} V_{REF45} + 10 KIAS

CAUTION: MULTIPLY THE FLAPS 45° UNFACTORED LANDING DISTANCE BY 1.45.

END

WARNING: DO NOT OPEN SPEEDBRAKE.

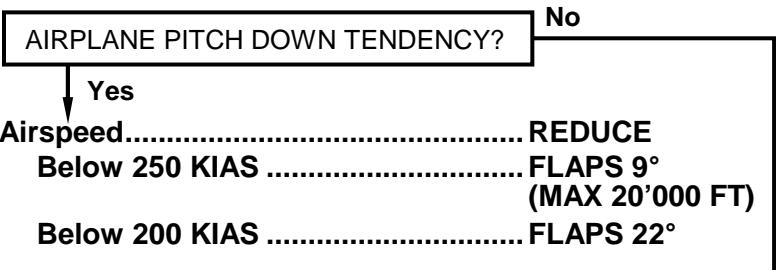

Landing Configuration:

Landing Gear DOWN

Delay gear extension as long as possible.

Flaps 22°

V_{REF} V_{REF45} + 25 KIAS

CAUTION: MULTIPLY THE FLAPS 45° UNFACTORED LANDING DISTANCE BY 1.75.

END

EMERGENCY/ABNORMAL PROCEDURES

Flight Controls

AILERON SYSTEM INOPERATIVE

EICAS Caution: AIL SYS 1 (2) INOP

Affected Aileron Shutoff PUSH OUT
Airspeed MAX 250 KIAS

BOTH SYSTEMS FAILED? No

Yes

Remaining Aileron Shutoff PUSH OUT
Autopilot DISENGAGE

Expect greater aileron control force. If required, both pilots should act together to control airplane.

Avoid landing at airports with anticipated turbulence, gusts or crosswind.

Perform a long final approach.

Landing Configuration:

Flaps 22°
V_{REF} V_{REF45} + 30 KIAS

CAUTION: MULTIPLY THE FLAPS 45° UNFACTORED LANDING DISTANCE BY 1.85.

END

User: aherrera - Printed By myTechCare - Jul 25/22 - 13:50:24

FLAP FAILURE

- EICAS Caution:** FLAP FAIL
Condition: Flap operation is not possible.
EICAS Indication: Flap position may become amber.

If flap indication on EICAS is not available, use the RMU Engine Backup Page 2 or flap position marks on the wing.

With flaps at intermediate positions, limit airspeed according to the following:

ALL MODELS EXCEPT EMB-145XR

FLAPS POSITION	MAX AIRSPEED
1° to 9°	250 KIAS
10° to 22°	200 KIAS
23° to 45°	145 KIAS

EMB-145XR MODEL

FLAPS POSITION	MAXIMUM AIRSPEED	ABOVE 10'000 ft AND Y/D DISENGAGED
1° to 9°	250 KIAS	250 KIAS
10° to 22°	180 KIAS	180 KIAS
23° to 45°	160 KIAS	145 KIAS

V_{REF}:

FLAPS POSITION	V _{REF}
0 to 8°	V _{REF45} + 30 KIAS
9° to 21°	V _{REF45} + 10 KIAS
22° to 44°	V _{REF45} + 5 KIAS
45°	V _{REF45}

At crew discretion:

EGPWS/GPWS CB's (J7 or J8)PULL

CAUTION: MULTIPLY THE FLAPS 45° UNFACTORED LANDING DISTANCE BY:

FLAPS POSITION	FACTOR
0 to 8°	1.65
9° to 21°	1.40
22° to 44°	1.40

END

EMERGENCY/ABNORMAL PROCEDURES

Flight Controls

FLAP LOW ACTUATION SPEED

EICAS Advisory: FLAP LOW SPEED

Anticipate flap slower actuation.

END

PITCH TRIM SWITCH INOPERATIVE

EICAS Caution: PTRIM CPT SW FAIL,
PTRIM F/O SW FAIL or
PTRIM BKP SW FAIL

CONDITION?

On Ground

In Flight

Use another serviceable switch.

END

Deenergize the airplane and energize it again.

END

RUDDER HARDOVER PROTECTION FAILURE

EICAS Caution: RUD HDOV PROTFAIL

Rudder hardover protection is not available.

END

RUDDER OVERBOOST

EICAS Caution: RUDDER OVERBOOST

Rudder Shutoff 2PUSH OUT

RUDDER OVERBOOST MESSAGE PERSISTS?

Yes

Rudder Shutoff 2PUSH IN

Rudder Shutoff 1PUSH OUT

Below 135 KIAS:

Rudder Shutoff 1PUSH IN

END

No

Below 135 KIAS:

Rudder Shutoff 2PUSH IN

END

User: aherrera - Printed By myTechCare - Jul 25/22 - 13:50:24

EMERGENCY/ABNORMAL PROCEDURES

Flight Controls

RUDDER SYSTEM INOPERATIVE

EICAS Caution: RUDDER SYS 1 (2) INOP or
RUDDER SYS 1-2 INOP

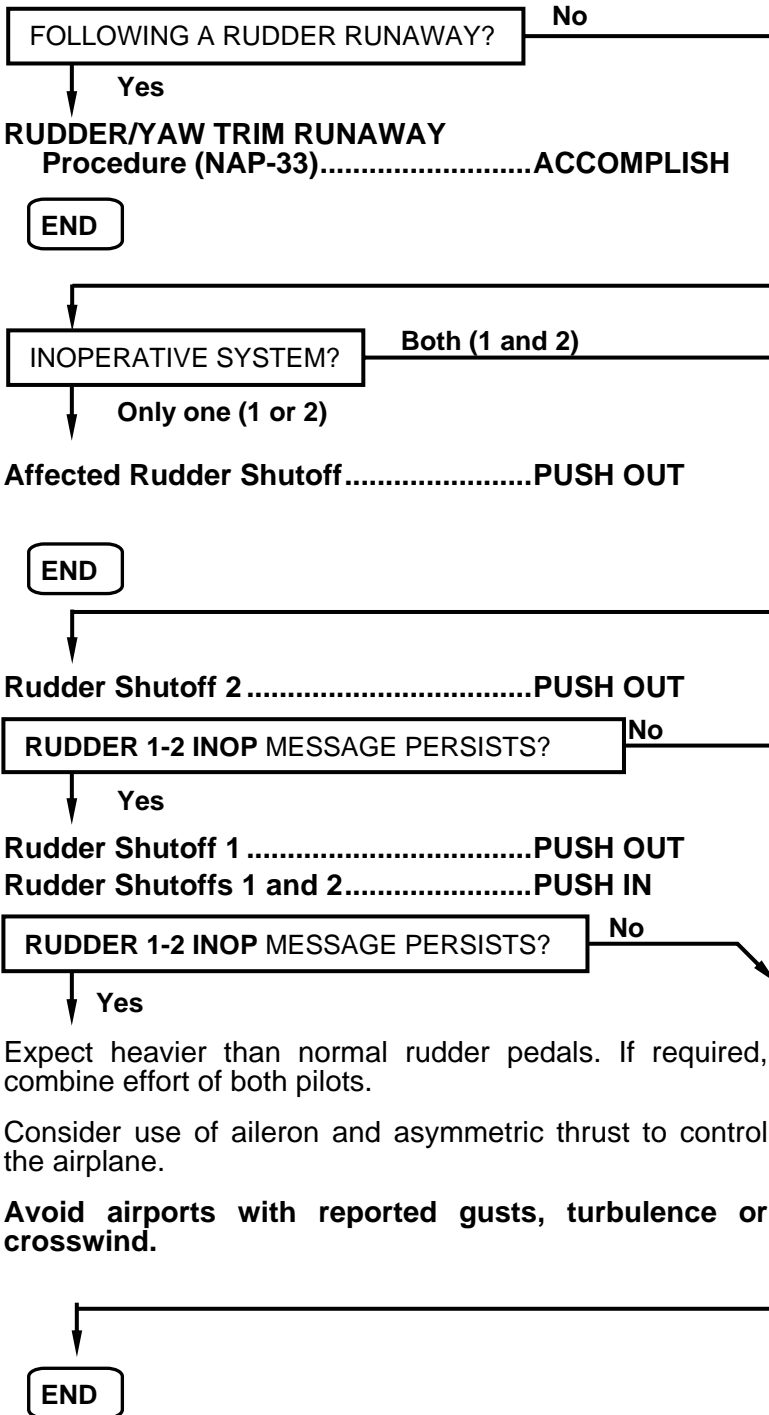

SPEED BRAKE LEVER DISAGREE

EICAS Caution: SPBK LVR DISAGREE

Speed Brake LeverCLOSE

END

User: aherrera - Printed By myTechCare - Jul 25/22 - 13:50:24

EMERGENCY/ABNORMAL PROCEDURES

Flight Controls

INTENTIONALLY BLANK

TABLE OF CONTENTS
ANNUNCIATED PROCEDURES

FUEL LOW LEVEL	EAP 9-3
FUEL TRANSFER CRITICAL	EAP 9-3
APU FUEL LOW PRESSURE	refer to EAP 3-4
APU FUEL SHUTOFF VALVE INOPERATIVE	EAP 9-4
DEFUEL VALVE NOT CLOSED	EAP 9-4
ENGINE FUEL FILTER IMPENDING BYPASS	refer to EAP 6-9
ENGINE FUEL LOW PRESSURE	EAP 9-5
ENGINE FUEL LOW TEMPERATURE	EAP 9-5
ENGINE FUEL SHUTOFF VALVE INOPERATIVE	EAP 9-6
FUEL CROSSFEED FAILURE.....	EAP 9-6
FUEL CROSSFEED MISCOMMAND	EAP 9-6
FUEL IMBALANCE	EAP 9-7
FUEL TANK LOW TEMPERATURE	EAP 9-7
FUEL TRANSFER ISOLATION FAILURE	EAP-9-8
FUEL TRANSFER OVERRIDE	EAP-9-8
FUEL TRANSFER SYSTEM INOPERATIVE	EAP-9-9
VENTRAL TANK VENTILATION OPEN	EAP-9-10
WING TANKS OVERFLOW	EAP-9-10

User: aherrera - Printed By myTechCare - Jul 25/22 - 13:50:24

EMERGENCY/ABNORMAL PROCEDURES

Fuel

LIST OF EICAS MESSAGES

FUEL 1 (2) LO LEVEL	EAP 9-3
FUEL XFER CRITICAL	EAP 9-3
APU FUEL LO PRESS	refer to EAP 3-4
APU FUEL SOV INOP	EAP 9-4
DEFUEL NOT CLOSED	EAP 9-4
E1 (2) FUEL LO PRESS	EAP 9-5
E1 (2) FUEL LO TEMP.....	EAP 9-5
E1 (2) FUEL SOV INOP	EAP 9-6
FUEL EQ XFEED OPN	EAP 9-6
FUEL IMBALANCE	EAP 9-7
FUEL TANK LO TEMP.....	EAP 9-7
FUEL VENT OPEN	EAP 9-10
FUEL XFEED FAIL.....	EAP 9-6
FUEL XFER OVRD	EAP 9-8
FUEL XFER INOP.....	EAP 9-9
FUEL XFER OVERFLOW	EAP 9-10
XFER ISOL FAIL.....	EAP 9-8

FUEL LOW LEVEL

EICAS Warning: FUEL 1 (2) LO LEVEL
MFD Indication: Fuel quantity in red range.

LAND AT THE NEAREST SUITABLE AIRPORT.

**Thrust Levers LONG RANGE
CRUISE**

Avoid attitudes in excess of 10° nose down or 12° nose up attitude, uncoordinated maneuvers and negative g's.

Xfeed Operation AS REQUIRED

END

FUEL TRANSFER CRITICAL

EICAS Warning: FUEL XFER CRITICAL

**Thrust Levers LONG RANGE
CRUISE**

Fuel Transfer System..... CHECK STATUS

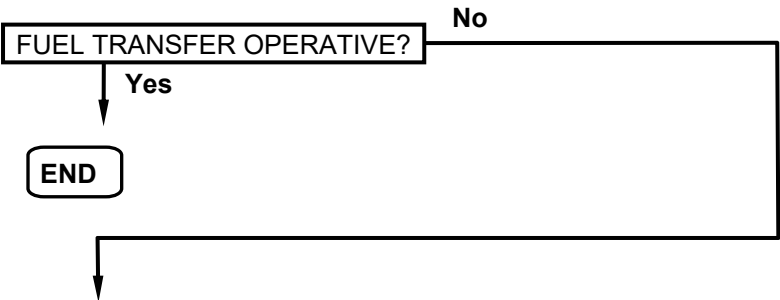

Consider diversion.

Remaining Fuel CHECK

Avoid rapid maneuvers and flying in severe turbulence conditions.

Before touchdown:

Rate of Descent MAX 450 FT/MIN

Touch smoothly the runway surface.

Reduce engine thrust only after touchdown.

END

User: aherrera - Printed By myTechCare - Jul 25/22 - 13:50:24

EMERGENCY/ABNORMAL PROCEDURES

Fuel

APU FUEL SHUTOFF VALVE INOPERATIVE

EICAS Caution: APU FUEL SOV INOP

APU Fuel Shutoff Button CHECK NOT PUSHED IN

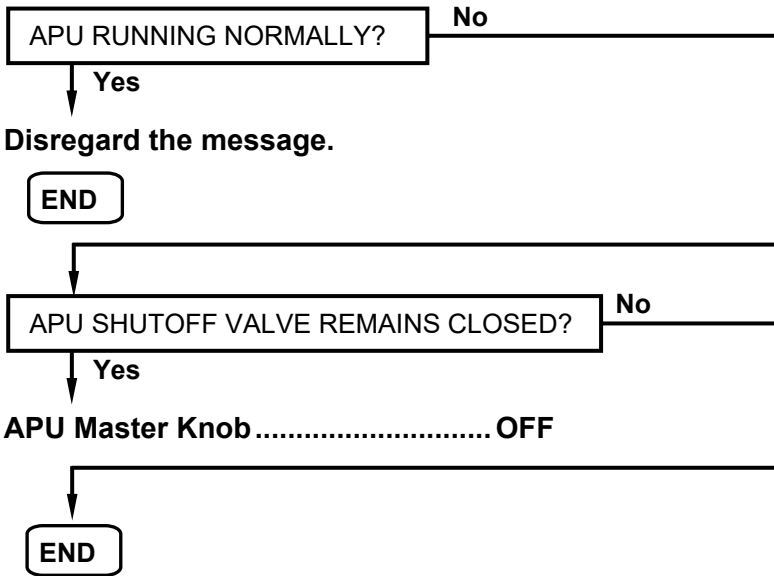

DEFUEL VALVE NOT CLOSED

EICAS Caution: DEFUEL NOT CLOSED

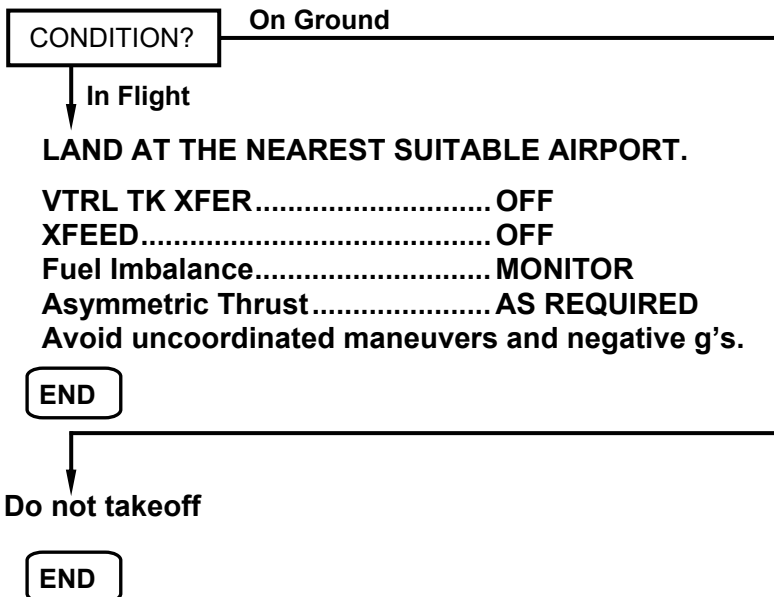

EMERGENCY/ABNORMAL PROCEDURES

Fuel

ENGINE FUEL LOW PRESSURE

EICAS Caution: E1 (2) FUEL LO PRESS

Condition: One or more affected tank electric fuel pump may be inoperative.

Associated Fuel Pump Sel **SELECT ANOTHER**

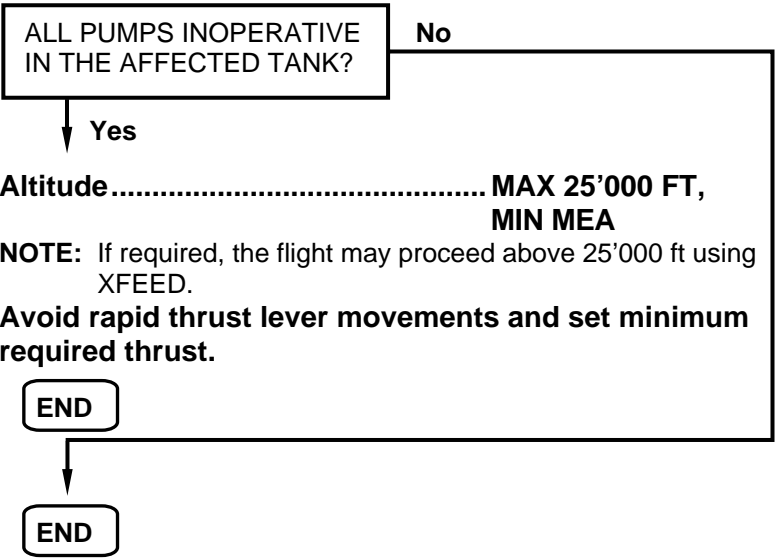

ENGINE FUEL LOW TEMPERATURE

EICAS Caution: E1 (2) FUEL LO TEMP

WARNING: IF NO ICING INHIBITOR WAS ADDED, ENGINE FLAMEOUT MAY OCCUR.

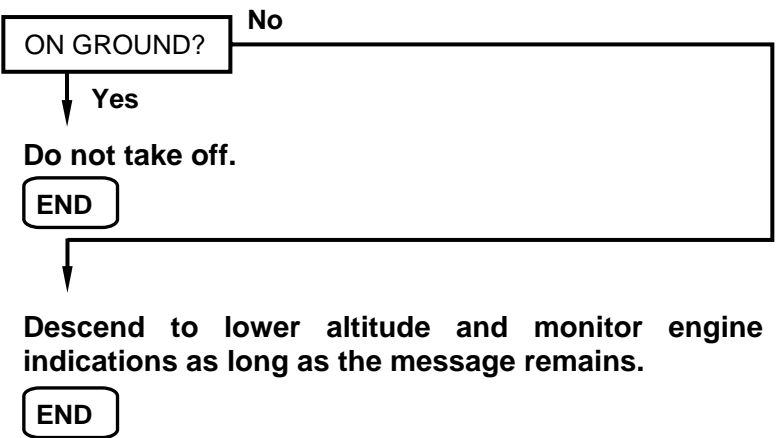

User: aherrera - Printed By myTechCare - Jul 25/22 - 13:50:24

EMERGENCY/ABNORMAL PROCEDURES

Fuel

ENGINE FUEL SHUTOFF VALVE INOPERATIVE

EICAS Caution: E1 (2) FUEL SOV INOP

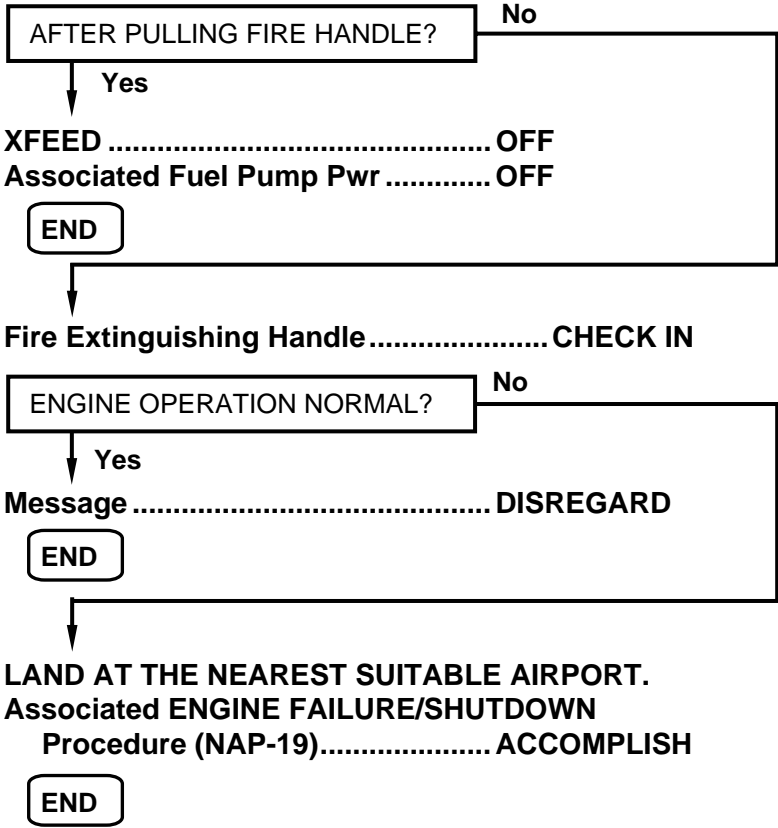

FUEL CROSSFEED FAILURE

EICAS Caution: FUEL XFEED FAIL

Fuel Imbalance MONITOR
Asymmetric Thrust..... AS REQUIRED

END

FUEL CROSSFEED MISCOMMAND

EICAS Caution: FUEL EQ XFEED OPN

XFEED OFF
Fuel Imbalance CHECK
XFEED AS REQUIRED
Check XFEED selector knob properly positioned to
correct wing fuel imbalance.

END

User: aherrera - Printed By myTechCare - Jul 25/22 - 13:50:24

EMERGENCY/ABNORMAL PROCEDURES

Fuel

FUEL IMBALANCE

EICAS Caution: FUEL IMBALANCE

NOTE: Crossfeed must be off during takeoff and landing.

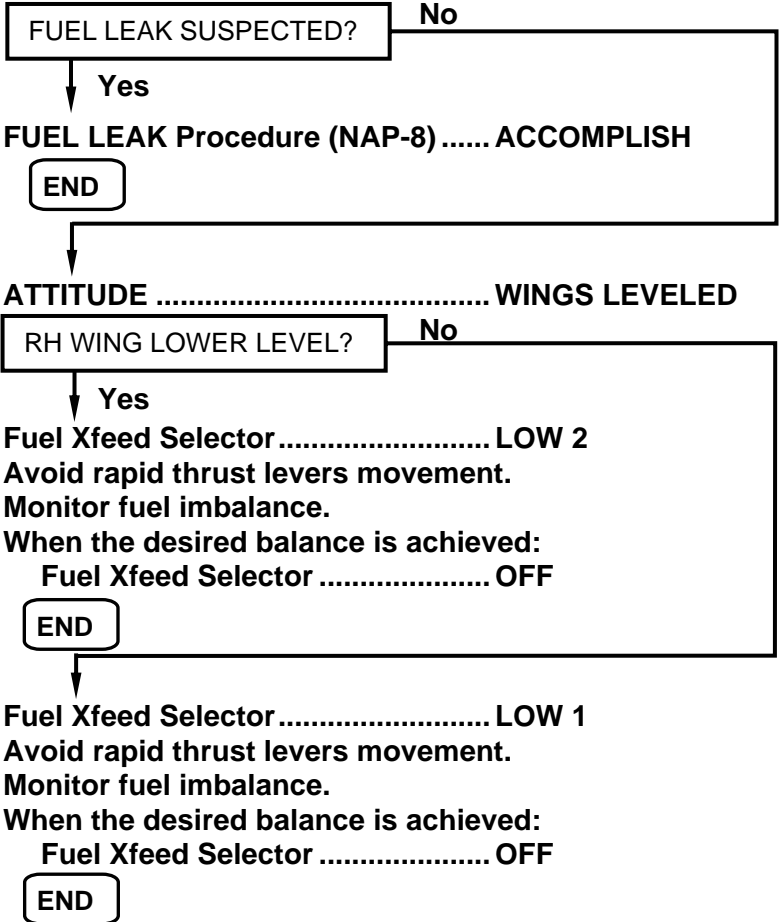

FUEL TANK LOW TEMPERATURE

EICAS Caution: FUEL TANK LO TEMP

MFD Indication: Fuel temperature in amber range.

WARNING: ENGINE FLAMEOUT MAY OCCUR.

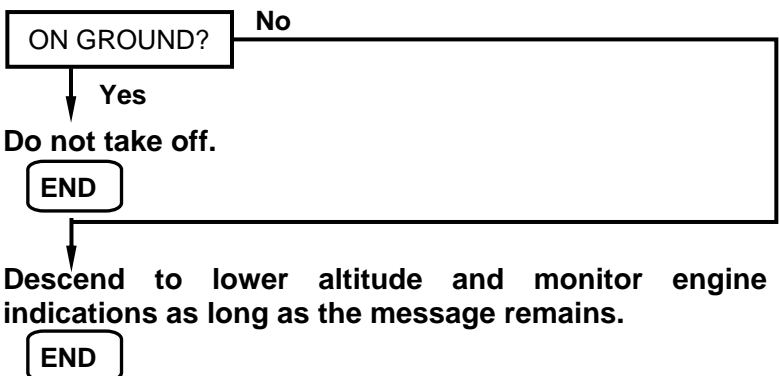

QRH-145/1115

EMERGENCY/ABNORMAL PROCEDURES

Fuel

FUEL TRANSFER ISOLATION FAILURE

EICAS Caution: XFER ISOL FAIL

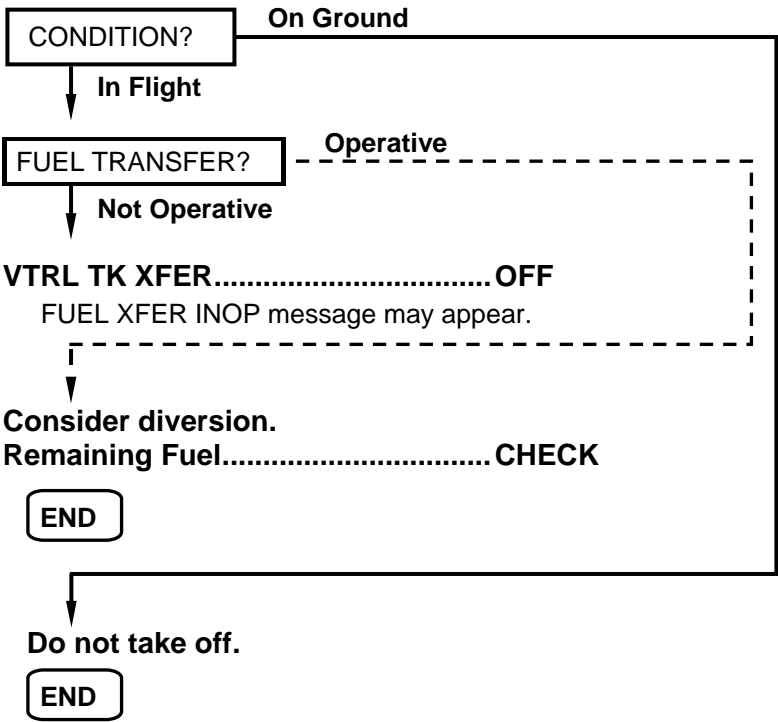

FUEL TRANSFER OVERRIDE

EICAS Advisory: FUEL XFER OVRD

When Ventral Tank Fuel Quantity is lower than 220 lb:

VTRL TK XFER..... OFF

END

FUEL TRANSFER SYSTEM INOPERATIVE

EICAS Caution: FUEL XFER INOP

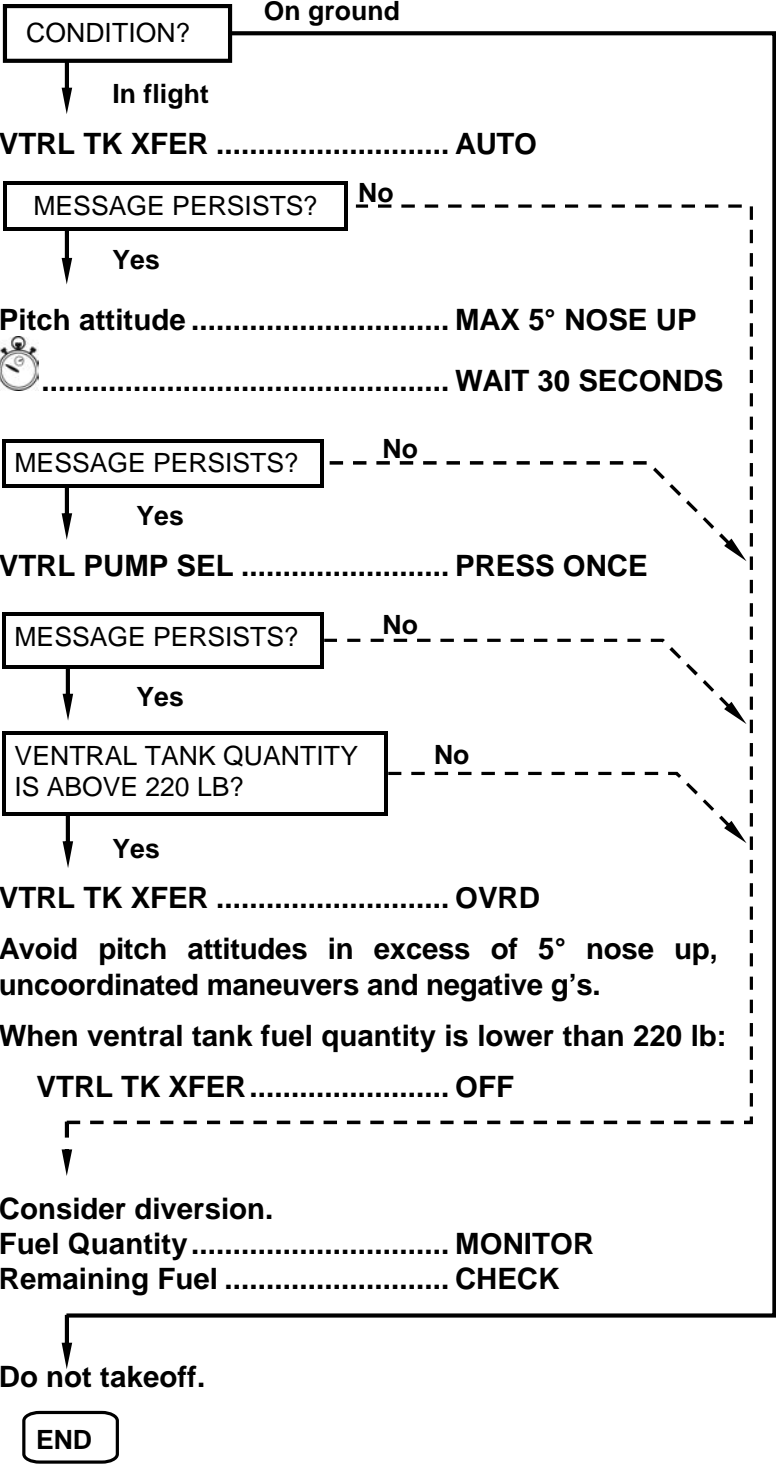

User: aherrera - Printed By myTechCare - Jul 25/22 - 13:50:24

EMERGENCY/ABNORMAL PROCEDURES

Fuel

VENTRAL TANK VENTILATION OPEN

EICAS Caution: FUEL VENT OPEN

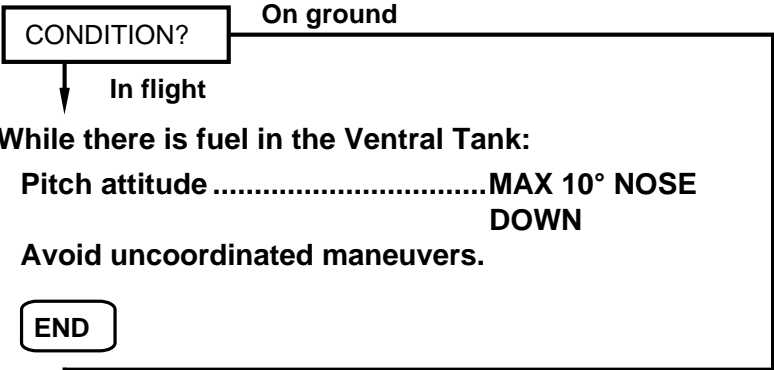

Do not takeoff.

END

WING TANKS OVERFLOW

EICAS Caution: FUEL XFER OVERFLOW

VTRL TK XFEROFF
Wing Fuel Tank QuantityMONITOR
XFEED.....AS REQUIRED

When Wing Fuel Tanks quantity is at 4630 lb or below:

VTRL TK XFERAUTO
Fuel ImbalanceMONITOR
XFEED.....AS REQUIRED

END

TABLE OF CONTENTS
ANNUNCIATED PROCEDURES

BOTH HYDRAULIC SYSTEMS FAILURE	EAP 10-3
HYDRAULIC SYSTEM 1 FAILURE	EAP 10-5
HYDRAULIC SYSTEM 2 FAILURE	EAP 10-6
HYDRAULIC SYSTEM LOW QUANTITY	EAP 10-7
HYDRAULIC SYSTEM OVERHEAT	EAP 10-7

User: aherrera - Printed By myTechCare - Jul 25/22 - 13:50:24

EMERGENCY/ABNORMAL PROCEDURES

Hydraulics

LIST OF EICAS MESSAGES

HYD SYS 1-2 FAIL	EAP 10-3
HYD SYS 1 FAIL.....	EAP 10-5
HYD SYS 2 FAIL.....	EAP 10-6
HYD SYS 1 (2) OVHT	EAP 10-7
HYD1 (2) LO QTY.....	EAP 10-7

User: aherrera - Printed By myTechCare - Jul 25/22 - 13:50:24

BOTH HYDRAULIC SYSTEMS FAILURE

EICAS Caution: HYD SYS 1-2 FAIL
MFD Indication: Hydraulic pressure may be amber.
Condition: Noise increase due to nose landing gear doors open.

The following messages will be displayed:

EICAS Caution: AIL SYS 1-2 INOP,
RUDDER SYS 1-2 INOP

EICAS Advisory: E1-2 HYD PUMP FAIL

CAUTION: DO NOT OPEN THE SPEED BRAKES.

Airspeed..... MAX 250 KIAS

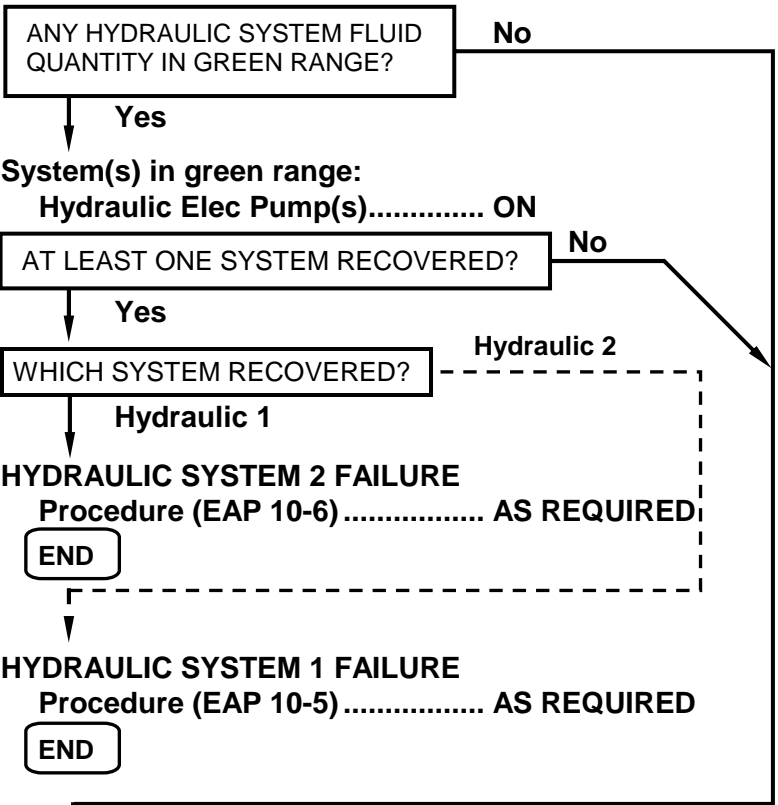

LAND AT THE NEAREST SUITABLE AIRPORT.

CAUTION: MULTIPLY THE FLAPS 45° UNFACTORED LANDING DISTANCE BY 3.45.

Autopilot/Yaw Damper DISENGAGE

Both Hydraulic Elec Pumps..... OFF

Expect greater aileron and rudder control force. If required, both pilots should act together to control airplane. Consider using aileron and asymmetric thrust to help yaw control.

CONTINUES ON NEXT PAGE

EMERGENCY/ABNORMAL PROCEDURES

Hydraulics

CONTINUED FROM PREVIOUS PAGE

Relevant Inoperative Items:

Normal gear extension	Thrust reversers	Anti-skid
Normal brakes	Spoilers	Steering
Main door retraction		

Approach:

- APU..... AS REQUIRED
- Altimeters..... SET AND CROSS CHECKED
- Approach Aids SET AND CROSS CHECKED
- Speed Bugs..... SET
- Pressurization..... CHECK
- Go-Around Procedure REVIEW

If necessary, accomplish a normal go-around procedure except that landing gear cannot be retracted.

Before Landing:

- Free Fall Lever ACTUATE
- Landing Gear Lever..... DOWN

Perform a long final approach.

Avoid landings at airports with anticipated crosswind or turbulence.

Excessive flare may require a bigger landing distance.

Use rudder for directional control on ground.

During landing run, pull Emergency Brake Handle carefully.

Landing Configuration:

- Landing Gear DOWN
- Flaps..... 22°
- V_{REF} V_{REF45} + 30 KIAS

CAUTION: MULTIPLY THE FLAPS 45° UNFACTORED LANDING DISTANCE BY 3.45.

END

HYDRAULIC SYSTEM 1 FAILURE

EICAS Caution: HYD SYS 1 FAIL

MFD Indication: Hydraulic pressure may be amber.
Condition: Noise increase due to nose landing gear doors open.

The following messages will be displayed:

EICAS Caution: AIL SYS 1 INOP,
 RUDDER SYS 1 INOP

EICAS Advisory: E1 HYD PUMP FAIL

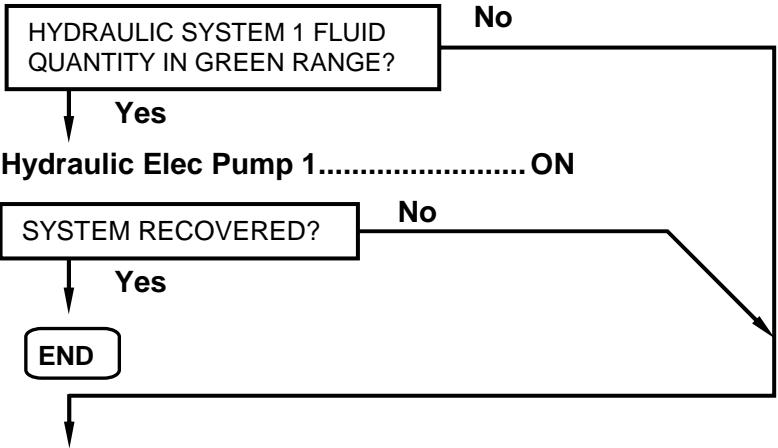

Hydraulic Elec Pump 1..... OFF
 Airspeed..... MAX 250 KIAS

Relevant Inoperative Items:

Inboard Spoiler	Normal gear extension	Thrust reverser 1
Steering	Main door retraction	Outboard brakes

Before Landing:

Free Fall Lever ACTUATE

Landing Gear Lever DOWN

Brake effectiveness will be reduced.

Do not actuate engine 1 Thrust Reverser.

Landing Configuration:

Landing Gear DOWN

Flaps 45°

V_{REF} V_{REF45}

CAUTION: MULTIPLY THE FLAPS 45° UNFACTORED LANDING DISTANCE BY 1.60.

END

EMERGENCY/ABNORMAL PROCEDURES

Hydraulics

HYDRAULIC SYSTEM 2 FAILURE

EICAS Caution: HYD SYS 2 FAIL

MFD Indication: Hydraulic pressure may be amber.

The following messages will be displayed:

EICAS Caution: AIL SYS 2 INOP,
RUDDER SYS 2 INOP

EICAS Advisory: E2 HYD PUMP FAIL

CAUTION: DO NOT OPEN THE SPEED BRAKES.

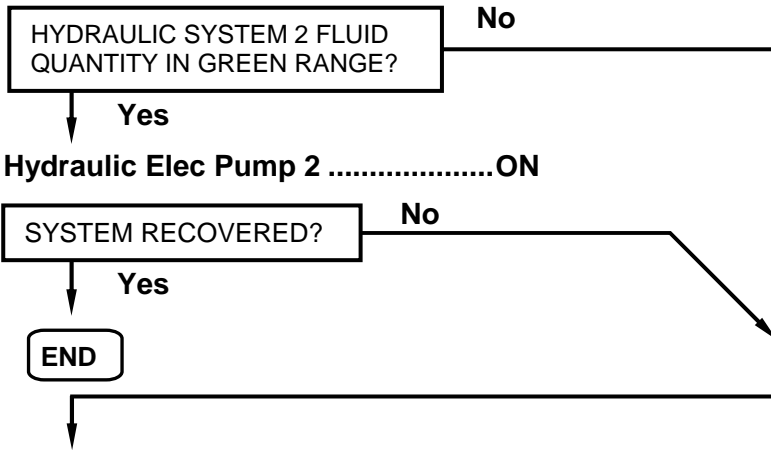

Hydraulic Elec Pump 2OFF

AirspeedMAX 250 KIAS

Relevant Inoperative Items:

Outboard Spoiler	Thrust reverser 2	Inboard brakes
------------------	-------------------	----------------

The Emergency/Parking Brake has accumulator pressure only.

Brake effectiveness will be reduced.

Do not actuate engine 2 Thrust Reverser.

Landing Configuration:

Landing GearDOWN

Flaps.....45°

V_{REF}.....V_{REF45}

CAUTION: MULTIPLY THE FLAPS 45° UNFACTORED LANDING DISTANCE BY 1.53.

END

HYDRAULIC SYSTEM LOW QUANTITY

EICAS Advisory: HYD1 (2) LO QTY

MFD Indication: Hydraulic fluid quantity may be amber.

Affected Hydraulic System MONITOR

NOTE: If Hydraulic System 2 is affected, do not open the Speed Brakes.

END

HYDRAULIC SYSTEM OVERHEAT

EICAS Caution: HYD SYS 1 (2) OVHT

Turn the affected system OFF:

Associated Hydraulic

Eng Pump Shutoff..... PUSH IN

Associated Hydraulic

Elec Pump OFF

EICAS Messages related to associated hydraulic system will be displayed while system is set to OFF.

Airspeed..... MAX 250 KIAS

For remainder of flight, if required:

**Affected Hydraulic System..... 15 MINUTES OFF,
1 MINUTE ON**

NOTE: To turn the hydraulic system ON, first turn the Hydraulic Elec Pump to AUTO. As soon as the system pressure is recovered, push out the Hydraulic Eng Pump Shutoff button.

During Approach and Landing or when required:

Affected Hydraulic System..... ON

After reaching taxi speed or when the system is no longer required:

Affected Hydraulic System..... OFF

END

EMERGENCY/ABNORMAL PROCEDURES

Hydraulics

INTENTIONALLY BLANK

TABLE OF CONTENTS
ANNUNCIATED PROCEDURES

ICING CONDITIONS WITH ANTI-ICING INOPERATIVE	EAP 11-3
ANTI-ICING LOW CAPACITY	EAP 11-4
ANTI-ICING SWITCH OFF	EAP 11-4
AOA HEATING INOPERATIVE	EAP 11-4
ENGINE ANTI-ICING FAILURE	EAP 11-5
ICE DETECTOR FAIL	EAP 11-5
NO ICE - ANTI-ICE ON	EAP 11-6
PITOT HEATING INOPERATIVE	EAP 11-6
STABILIZER ANTI-ICING FAILURE	EAP 11-8
TAT HEATING INOPERATIVE	EAP 11-7
WINDSHIELD HEATING FAILURE	EAP 11-7
WING ANTI-ICING FAILURE	EAP 11-8

NON ANNUNCIATED PROCEDURES

SINGLE ENGINE BLEED OPERATION IN ICING CONDITIONS	refer to NAP-34
--	------------------------

User: aherrera - Printed By myTechCare - Jul 25/22 - 13:50:24

EMERGENCY/ABNORMAL PROCEDURES

Ice & Rain Protection

LIST OF EICAS MESSAGES

ICE COND-A/I INOP	EAP 11-3
A/ICE LOW CAPACIT	EAP 11-4
A/ICE SWITCH OFF	EAP 11-4
AOA 1 (2) HEAT INOP	EAP 11-4
E1 (2) A/ICE FAIL	EAP 11-5
ICE DET1 (2) FAIL	EAP 11-5
ICE DETECTORS FAIL	EAP 11-5
NO ICE-A/ICE ON	EAP 11-6
PITOT 1 (2, 3) INOP	EAP 11-6
STAB A/ICE FAIL	EAP 11-8
TAT 1 (2) HEAT INOP	EAP 11-7
W/S 1 (2) HEAT FAIL	EAP 11-7
WG A/ICE FAIL	EAP 11-8

User: aherrera - Printed By myTechCare - Jul 25/22 - 13:50:24

ICING CONDITIONS WITH ANTI-ICING INOPERATIVE

EICAS Warning: ICE COND-A/I INOP

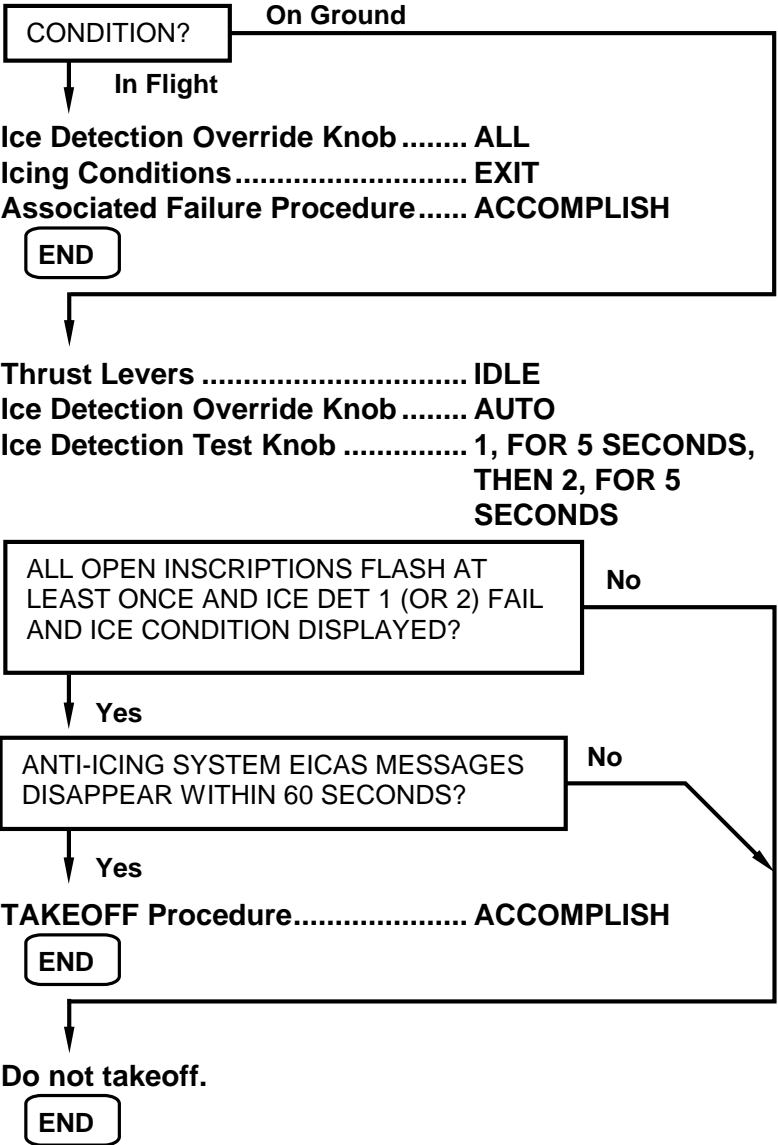

User: aherrera - Printed By myTechCare - Jul 25/22 - 13:50:24

EMERGENCY/ABNORMAL PROCEDURES

Ice & Rain Protection

ANTI-ICING LOW CAPACITY

EICAS Caution: A/ICE LOW CAPACIT

Thrust LeversADVANCE

Advance Thrust Levers to at least 55% N1.



.....**WAIT 5 SECONDS**

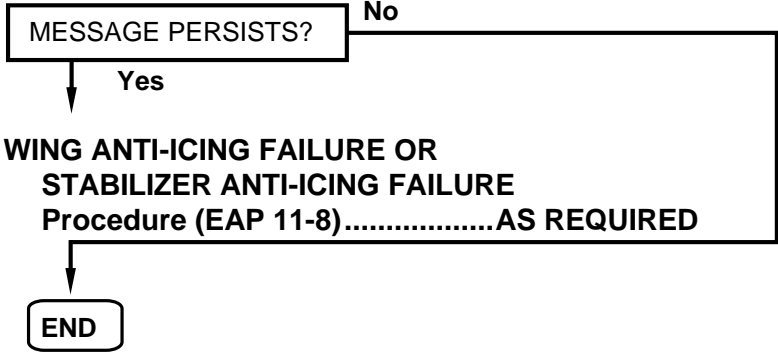

ANTI-ICING SWITCH OFF

EICAS Caution: A/ICE SWITCH OFF

All Ice Protection ButtonsPUSH IN

END

AOA HEATING INOPERATIVE

EICAS Caution: AOA 1 (2) HEAT INOP

**Minimum AirspeedFLAP
MANEUVERING
SPEED (PD-2)**

END

User: aherrera - Printed By myTechCare - Jul 25/22 - 13:50:24

ENGINE ANTI-ICING FAILURE

EICAS Caution: E1 (2) A/ICE FAIL

Thrust Levers ADVANCE

MESSAGE PERSISTS?

No

Yes

Ice Detection Override Knob ALL

MESSAGE STILL PERSISTS?

No

Yes

Ice Protection Engine Air Inlet PUSH OUT, THEN PUSH IN

MESSAGE STILL PERSISTS?

No

Yes

Icing Conditions AVOID/EXIT

Two minutes after exiting icing conditions:

Ice Detection Override Knob AUTO

Engine Vibration MONITOR

If vibration increases, advance thrust levers one at a time, to 60% N1 minimum for 5 seconds.

If vibration increases to unacceptable values or engine parameters indicate abnormal values, exit icing conditions.

END

ICE DETECTOR FAIL

EICAS Caution: ICE DET1 (2) FAIL or
ICE DETECTORS FAIL

When flying in icing conditions:

Ice Detection Override Knob ALL

Two minutes after exiting icing conditions:

Ice Detection Override Knob AUTO

END

User: aherrera - Printed By myTechCare - Jul 25/22 - 13:50:24

EMERGENCY/ABNORMAL PROCEDURES

Ice & Rain Protection

NO ICE - ANTI-ICE ON

EICAS Caution: NO ICE-A/ICE ON

Ice Detection Override Knob.....AUTO

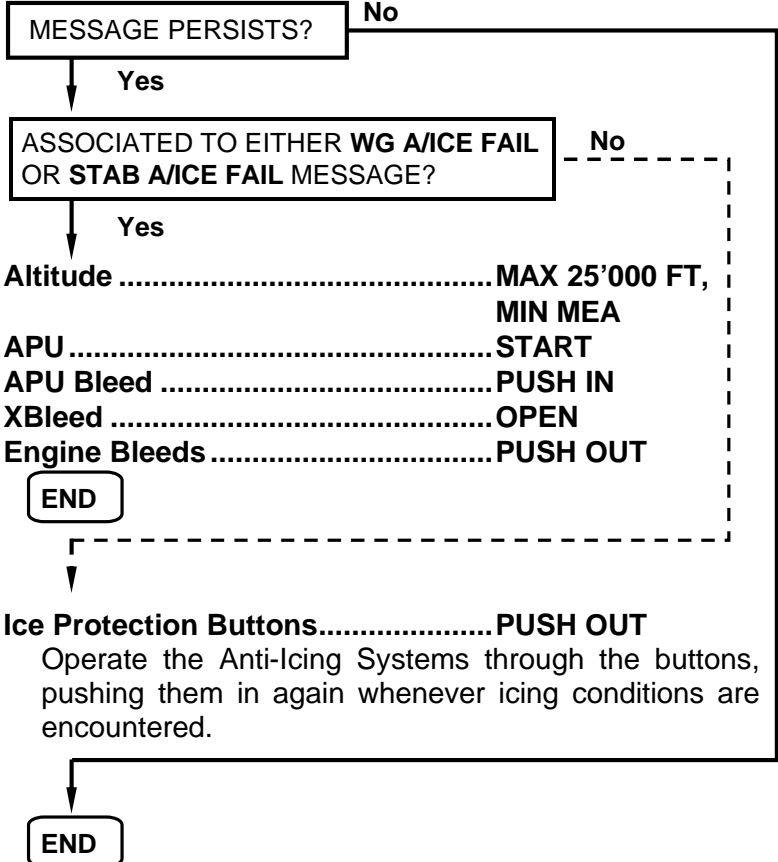

PITOT HEATING INOPERATIVE

EICAS Caution: PITOT 1 (2, 3) INOP

Instruments' information supplied by the affected system may be unreliable. Cross-check and do not use the affected system if a disagreement is found. If the Pitot 3 heating is inoperative, standby instruments and pressurization system may be affected.

If necessary:

- ADC on Associated
- Reversionary Panel.....PUSH IN

END

User: aherrera - Printed By myTechCare - Jul 25/22 - 13:50:24

EMERGENCY/ABNORMAL PROCEDURES

Ice & Rain Protection

TAT HEATING INOPERATIVE

EICAS Caution: TAT 1 (2) HEAT INOP

TAT, TAS and SAT indication may be unreliable.

END

WINDSHIELD HEATING FAILURE

EICAS Caution: W/S 1 (2) HEAT FAIL

Associated Ice Protection

Windshield PUSH OUT

END

User: aherrera - Printed By myTechCare - Jul 25/22 - 13:50:24

EMERGENCY/ABNORMAL PROCEDURES

Ice & Rain Protection

WING ANTI-ICING FAILURE OR STABILIZER ANTI-ICING FAILURE

EICAS Caution: STAB A/ICE FAIL or WG A/ICE FAIL

Ice Detector Override Knob..... ALL

Thrust Levers ADVANCE

MESSAGE PERSISTS? No
↓ Yes

Affected Ice Protection Button..... **PUSH OUT, THEN PUSH IN**

MESSAGE STILL PERSISTS? No
↓ Yes

Associated Ice Protection Button..... **PUSH OUT**
Icing Conditions..... **AVOID/EXIT**

Two minutes after exiting icing conditions:

Ice Detector Override Knob AUTO

Maximum Bank Angle..... 30°

Minimum Airspeed (Flaps 0° or 9°)..... 190 KIAS

LANDING IN ICING CONDITIONS OR WITH ICE ACCRETION? No
↓ Yes

AFFECTED SYSTEM(S)? Stab
↓ **Wing or Wing+Stab**

Landing configuration:

Flaps..... 22°

V_{REF}..... **V_{REF45} + 30 KIAS**

CAUTION: MULTIPLY THE FLAPS 45° UNFACTORED LANDING DISTANCE BY 1.85.

END

Landing configuration:

Flaps..... 22°

V_{REF}..... **V_{REF45} + 15 KIAS**

CAUTION: MULTIPLY THE FLAPS 45° UNFACTORED LANDING DISTANCE BY 1.55.

END

User: aherrera - Printed By myTechCare - Jul 25/22 - 13:50:24

TABLE OF CONTENTS

ANNUNCIATED PROCEDURES

LANDING GEAR/LEVER DISAGREE	EAP 12-3
BRAKE OVERHEAT	EAP 12-4
BRAKES DEGRADED	EAP 12-5
BRAKES INOPERATIVE.....	EAP 12-5
EMERGENCY/PARKING BRAKE LOW PRESSURE.....	EAP 12-5
LANDING GEAR AIR/GROUND SYSTEM FAILURE.....	EAP 12-6
STEERING SYSTEM INOPERATIVE	EAP 12-7
UNCOMMANDED SWERVING ON GROUND.....	EAP 12-7

NON ANNUNCIATED PROCEDURES

ABNORMAL LANDING GEAR EXTENSION.....	refer to NAP-13
EMERGENCY/PARKING BRAKE HANDLE DISAGREE.....	refer to NAP-15
GEAR LEVER CANNOT MOVE UP AFTER TAKEOFF	refer to NAP-22
NOSE LANDING GEAR UP DOOR OPEN	refer to NAP-30
PARTIAL OR GEAR UP LANDING	refer to NAP-32

User: aherrera - Printed By myTechCare - Jul 25/22 - 13:50:24

EMERGENCY/ABNORMAL PROCEDURES

Landing Gear & Brakes

LIST OF EICAS MESSAGES

LG/LEVER DISAGREE	EAP 12-3
BRAKE OVERHEAT	EAP 12-4
BRAKE DEGRADED.....	EAP 12-5
BRK INBD INOP	EAP 12-5
BRK OUTBD INOP	EAP 12-5
EMRG BRK LO PRES	EAP 12-5
LG AIR/GND FAIL.....	EAP 12-6
STEER INOP	EAP 12-7

User: aherrera - Printed By myTechCare - Jul 25/22 - 13:50:24

LANDING GEAR/LEVER DISAGREE

EICAS Warning: LG/LEVER DISAGREE
EICAS Caution: NLG UP/DOOR OPN may be displayed.
EICAS Indication: Landing gear abnormal indication.
Condition: Landing gear cannot move to desired position.

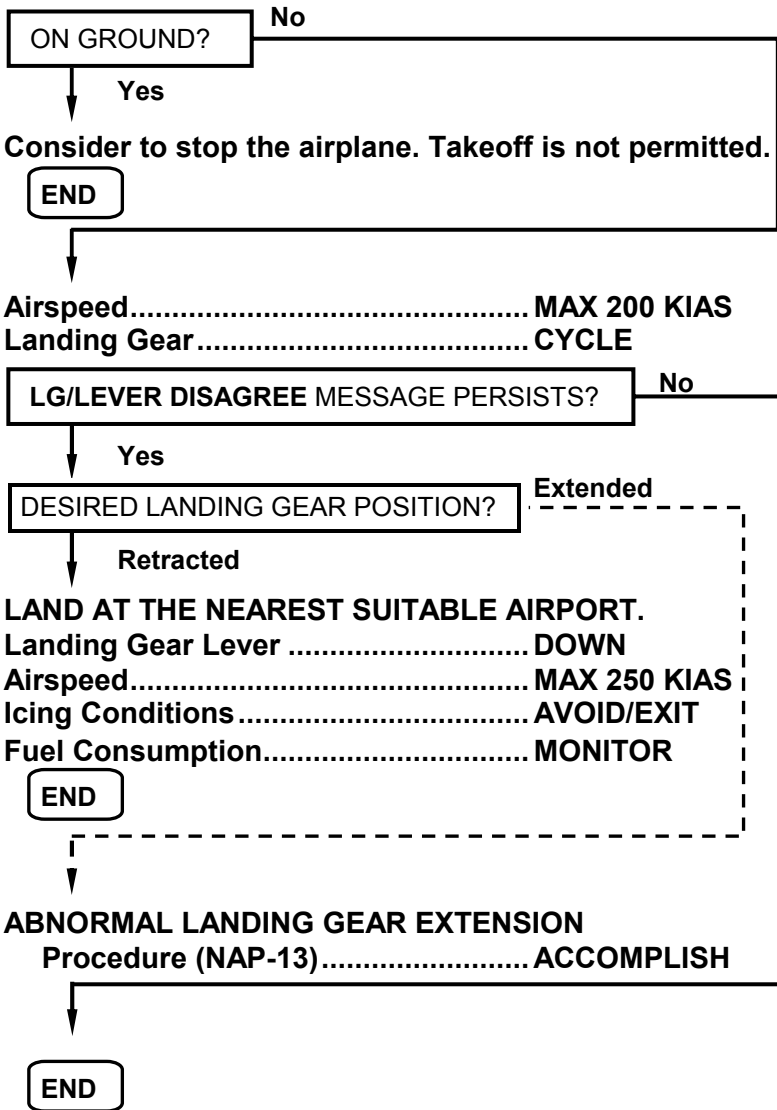

User: aherrera - Printed By myTechCare - Jul 25/22 - 13:50:24

EMERGENCY/ABNORMAL PROCEDURES

Landing Gear & Brakes

BRAKE OVERHEAT

EICAS Caution: BRAKE OVERHEAT

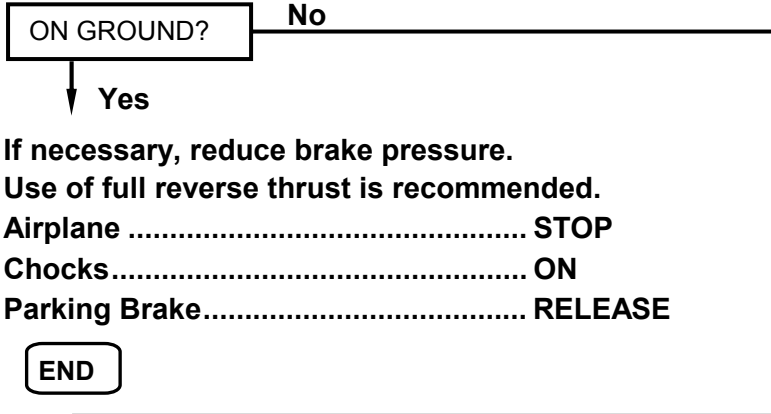

Airspeed MAX 250 KIAS
Landing Gear Lever DOWN
Brakes Temperature CHECK IN THE GREEN RANGE

If MFD is not available, retract gear after message is removed.

Airspeed MAX 200 KIAS
Landing Gear Lever UP
Thrust Rating AS REQUIRED

END

EMERGENCY/ABNORMAL PROCEDURES

Landing Gear & Brakes

BRAKES DEGRADED

EICAS Caution: BRAKE DEGRADED

Brake effectiveness and symmetry may be affected.

CAUTION: MULTIPLY THE FLAPS 45° UNFACTORED LANDING DISTANCE BY 1.24.

During landing run:

Brakes **APPLY NORMALLY**
Use thrust reverser if available.

END

BRAKES INOPERATIVE

EICAS Caution: BRK OUTBD (INBD) INOP

CAUTION: MULTIPLY THE FLAPS 45° UNFACTORED LANDING DISTANCE BY 1.45.

During landing run:

If available, use thrust reverser.

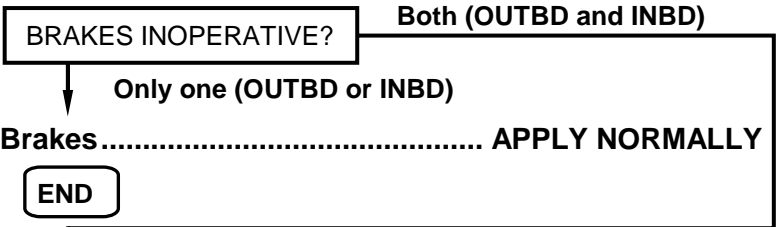

Emergency Brake Handle **PULL CAREFULLY**
Relevant Inoperative Item: **Anti-skid**

END

EMERGENCY/PARKING BRAKE LOW PRESSURE

EICAS Caution: EMRG BRK LO PRES

Emergency/Parking Brake performance may be degraded.

When parking the airplane, use wheel chocks.

END

User: aherrera - Printed By myTechCare - Jul 25/22 - 13:50:24

EMERGENCY/ABNORMAL PROCEDURES

Landing Gear & Brakes

LANDING GEAR AIR/GROUND SYSTEM FAILURE

EICAS Caution: LG AIR/GND FAIL

- NOTE:** - Thrust Reversers, Steering and Ground Spoiler may not be available.
- Depending on the failed condition, Ground Idle may not be selectable.
 - If the message is presented on ground, a loss of the main brake capacity may occur (below 10 kt ground speed) and steering may not be available.
 - Refer to the associated procedures for each case.

ICING CONDITIONS?

No

Yes

Anti-Icing System..... MONITOR

If any anti-ice valve does not open or anti-ice failure messages appear, exit and avoid icing conditions.

After exiting icing conditions, proceed as follows:

Maximum Bank Angle..... 30°

**Minimum Airspeed for
Flaps up or 9° 190 KIAS**

Landing Configuration:

Flaps 22°

Airspeed..... $V_{REF 45} + 30$ KIAS

CAUTION: MULTIPLY THE FLAPS 45° UNFACTORED LANDING DISTANCE BY 2.40.

END

Icing Conditions..... EXIT/AVOID

Landing Configuration:

Flaps 45°

Airspeed..... $V_{REF 45}$

CAUTION: MULTIPLY THE FLAPS 45° UNFACTORED LANDING DISTANCE BY 1.70.

END

**STEERING SYSTEM INOPERATIVE OR
UNCOMMANDED SWERVING ON
GROUND**

EICAS Caution: STEER INOP may be displayed.

**Steering Handwheel..... DO NOT USE
Steering Disengagement Button..... PRESS**

Control the airplane using differential brakes and rudder.

Consider the use of differential thrust if serviceable.

END

User: aherrera - Printed By myTechCare - Jul 25/22 - 13:50:24

EMERGENCY/ABNORMAL PROCEDURES

Landing Gear & Brakes

INTENTIONALLY BLANK

EMERGENCY/ABNORMAL PROCEDURES

Oxygen

TABLE OF CONTENTS

ANNUNCIATED PROCEDURES

CREW OXYGEN LOW PRESSURE EAP 13-3

OXYGEN LOW PRESSURE EAP 13-3

PASSENGER OXYGEN LOW PRESSURE EAP 13-3

NON ANNUNCIATED PROCEDURES

OXYGEN LEAKAGE refer to NAP-31

User: aherrera - Printed By myTechCare - Jul 25/22 - 13:50:24

EMERGENCY/ABNORMAL PROCEDURES

Oxygen

LIST OF EICAS MESSAGES

CREW OXYGEN LO PRESS.....	EAP 13-3
OXYGEN LO PRESS.....	EAP 13-3
PAX OXYGEN LO PRESS	EAP 13-3

User: aherrera - Printed By myTechCare - Jul 25/22 - 13:50:24

EMERGENCY/ABNORMAL PROCEDURES

Oxygen

(CREW/PASSENGER) OXYGEN LOW PRESSURE

EICAS Caution: OXYGEN LO PRESS
CREW (PAX) OXYGEN LO PRESS

MFD Indication: Oxygen pressure red or amber.

Altitude **MEA OR 10'000 FT,
WHICHEVER IS
HIGHER**

END

User: aherrera - Printed By myTechCare - Jul 25/22 - 13:50:24

EMERGENCY/ABNORMAL PROCEDURES

Oxygen

INTENTIONALLY BLANK

TABLE OF CONTENTS

ANNUNCIATED PROCEDURES

STALL PROTECTION INOPERATIVE	EAP 14-3
STICK PUSHER FAILURE	EAP 14-4
TAKEOFF CONFIGURATION WARNING	EAP 14-4
ADVANCED STALL PROTECTION	EAP 14-5
AURAL WARNING FAIL	EAP 14-6
GPWS INOPERATIVE	EAP 14-6
WINDSHEAR DETECTION INOPERATIVE	EAP 14-6

NON ANNUNCIATED PROCEDURES

AIRPLANE OVERSPEED	refer to NAP-4
ERRONEOUS STALL PROTECTION ACTUATION	refer to NAP-22

EMERGENCY/ABNORMAL PROCEDURES

Warning System

LIST OF EICAS MESSAGES

SPS 1 (2) INOP	EAP 14-3
SPS 1-2 INOP	EAP 14-4
NO TAKEOFF CONFIG	EAP 14-4
AURAL WARN FAIL	EAP 14-6
GPWS INOP	EAP 14-6
SPS ADVANCED	EAP 14-5
STICK PUSHER FAIL	EAP 14-4
TERR INOP	EAP 14-6
WINDSHEAR INOP	EAP 14-6

User: aherrera - Printed By myTechCare - Jul 25/22 - 13:50:24

STALL PROTECTION INOPERATIVE

EICAS Warning: SPS 1 (2) INOP
EICAS Caution: SPS ADVANCED

Affected Stall Protection

Cutout Button PUSH OUT

The following messages will be displayed:

EICAS Warning: SPS 1 (2) INOP
EICAS Caution: STICK PUSHER FAIL

**Minimum Airspeed FLAP
MANEUVERING
SPEED (PD-2)**

Avoid skidding the airplane.

Add 5 KIAS to approach and go-around speeds.

Landing configuration:

**Landing Gear DOWN
Flaps 45°
Airspeed V_{REF 45} + 5 KIAS**

NOTE: - The remaining stick shaker is available.
- Stick pusher is not available.

CAUTION: MULTIPLY THE FLAPS 45° UNFACTORED
LANDING DISTANCE BY 1.10.

END

User: aherrera - Printed By myTechCare - Jul 25/22 - 13:50:24

EMERGENCY/ABNORMAL PROCEDURES

Warning System

STICK PUSHER FAILURE

EICAS Warning: SPS 1-2 INOP
EICAS Caution: STICK PUSHER FAIL

Stall RECOVER
Minimum Airspeed FLAP
MANEUVERING
SPEED (PD-2)

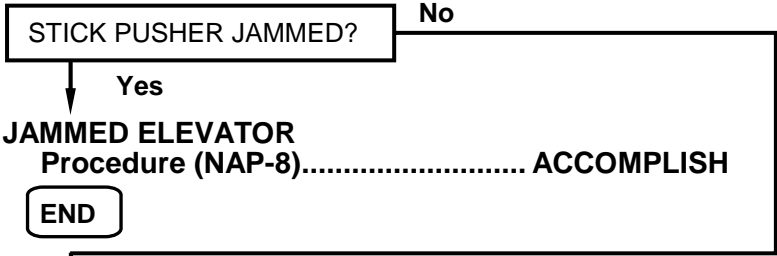

Both stick shaker 1 and 2 are still available.
Add 5 KIAS to V_{REF} , approach and approach-climb speeds.

CAUTION: MULTIPLY THE FLAPS 45° UNFACTORED LANDING DISTANCE BY 1.15.

END

TAKEOFF CONFIGURATION WARNING

EICAS Warning: NO TAKEOFF CONFIG
Aural Warning: Voice Messages TAKEOFF-BRAKES,
TAKEOFF-FLAPS, TAKEOFF-TRIM,
TAKEOFF-SPOILERS

EICAS Indication: Spoiler and pitch trim may be red.

Do not take off.
Airplane Configuration CORRECT
TO Config Button PRESS

END

EMERGENCY/ABNORMAL PROCEDURES

Warning System

ADVANCED STALL PROTECTION

EICAS Caution: SPS ADVANCED

Above 25'000 ft:

Minimum Airspeed..... 150 KIAS

Below 25'000 ft:

Minimum Airspeed..... FLAP
MANEUVERING
SPEED (PD-2)

Add 5 KIAS to approach and go-around speeds.

Landing configuration:

Landing Gear DOWN

Flaps..... 45°

Airspeed..... $V_{REF45} + 5$ KIAS

CAUTION: MULTIPLY THE FLAPS 45° UNFACTORED
LANDING DISTANCE BY 1.10.

END

EMERGENCY/ABNORMAL PROCEDURES

Warning System

AURAL WARNING FAIL

EICAS Caution: AURAL WARN FAIL

Visually monitor every EICAS, MFD and PFD indication specially related to TCAS, Windshear Detection, GPWS, IC-600, Fire Detection, Stall Protection, Trims, Flaps, Brakes, Spoilers, Radio Altimeter, Autopilot, Landing gear, ADC, Pressurization, SELCAL. No aural warning will be available.

Do not perform CAT II or CAT III approaches.

END

GPWS INOPERATIVE

EICAS Caution: GPWS INOP or
GPWS INOP and TERR INOP (for
EGPWS)

Monitor visually any trend toward terrain contact, excessive sink rate, marginal flight path and airplane configuration. No aural warning related to the system will be available.

END

WINDSHEAR DETECTION INOPERATIVE

EICAS Caution: WINDSHEAR INOP

Windshear detection is not available.

END

PERFORMANCE DATA

ALL ENGINES

WIND COMPONENT TABLE																								
ANGLE BETWEEN WIND DIRECTION AND HEADING (LEFT OR RIGHT)																								
HEADWIND COMPONENT (kt)										TAILWIND COMPONENT (kt)														
WIND SPEED (kt)	10	20	30	40	50	60	70	80	100	110	120	130	140	150	160	170	10	20	30	40	50	60	70	80
5	5	5	4	4	3	3	2	1	-1	-2	-3	-3	-4	-4	-5	-5	1	2	3	3	4	4	5	5
10	10	9	9	8	6	5	3	2	-2	-3	-5	-6	-8	-9	-9	-10	2	3	5	6	8	9	9	10
15	15	14	13	11	10	8	5	3	-3	-5	-8	-10	-11	-13	-14	-15	3	5	8	10	11	13	14	15
20	20	19	17	15	13	10	7	3	-3	-7	-10	-13	-15	-17	-19	-20	3	7	10	13	15	17	19	20
25	25	23	22	19	16	13	9	4	-4	-9	-13	-16	-19	-22	-23	-25	4	9	13	16	19	22	23	25
30	30	28	26	23	19	15	10	5	-5	-10	-15	-19	-23	-26	-28	-30	5	10	15	19	23	26	28	30
35	34	33	30	27	22	18	12	6	-6	-12	-18	-22	-27	-30	-33	-34	6	12	18	22	27	30	33	34
40	39	38	35	31	26	20	14	7	-7	-14	-20	-26	-31	-35	-38	-39	7	14	20	26	31	35	38	39
45	44	42	39	34	29	23	15	8	-8	-15	-23	-29	-34	-39	-42	-44	8	15	23	29	34	39	42	44
50	49	47	43	38	32	25	17	9	-9	-17	-25	-32	-38	-43	-47	-49	9	17	25	32	38	43	47	49

Example: Given Wind Speed=20 kt and Angle (between wind and nose)= 30°, the Headwind Component is 17 kt and the Crosswind component is 10 kt. Shaded areas are not allowed for CAT II operations.

REFERENCE CROSSWIND VALUES					
Ice	-	Standing Water/ Slush/ Dry Snow	Compacted Snow	Dry/ Wet	Surface Condition
Poor	Medium	-	Good	-	Brake Action
<0.20	0.30	-	0.40	-	Friction Coefficient
10 kt	17 kt	20 kt	25 kt	30 kt	Reference Crosswind

PERFORMANCE DATA

ALL ENGINES

PITCH TRIM UNITS						
EMB-145	CG POSITION (%)	LESS THAN OR EQUAL TO 27.5	27.6 UP TO 32.5	32.6 UP TO 36.5	36.6 UP TO 41.5	ABOVE OR EQUAL TO 41.6
	PITCH TRIM UNITS	8	7	6	5	4

FLAP RETRACTION SCHEDULE		
ALL ENGINES	<i>For a flaps 9° takeoff:</i> Flaps 9° to UP	V ₂ + 15 KIAS
A1P and A1/3 ENGINES	<i>For a flaps 18° takeoff:</i> Flaps 18° to 9° Flaps 9° to UP	V ₂ + 10 KIAS V ₂ + 30 KIAS
A, A1, A1/1 ENGINES	<i>For a flaps 22° takeoff:</i> Flaps 22° to 9° Flaps 9° to UP	V ₂ + 5 KIAS V ₂ + 25 KIAS
A1P ENGINES	<i>For a flaps 22° takeoff:</i> Flaps 22° to 9° Flaps 9° to UP	V ₂ + 10 KIAS V ₂ + 30 KIAS
FLAP MANEUVERING SPEED		
GEAR-FLAP	No Icing Conditions	Icing Conditions
UP-0°	180 KIAS	200 KIAS
UP/DN-9°	160 KIAS	160 KIAS
UP/DN-18°/22°	140 KIAS	150 KIAS
DN-45°	140 KIAS	140 KIAS

PERFORMANCE DATA

AE3007A1P ENGINES

UNRELIABLE AIRSPEED TABLES (CLB Thrust Mode)

Airplane: EMB-145 – Engine: AE3007A1 & A1P – Anti-Ice: OFF

PRESSURE ALTITUDE (ft)		WEIGHT (lb)					
		30000	35000	40000	45000	50000	55000
0 (240 KIAS)	Pitch (deg)	13	12	11	10	10	9
	V/S (ft/min)	4800	4000	3400	2900	2500	2200
10000 (240 KIAS)	Pitch (deg)	10	9	8	8	8	7
	V/S (ft/min)	3800	3100	2700	2200	1900	1600
20000 (0.56 M)	Pitch (deg)	7	6	6	5	5	5
	V/S (ft/min)	3500	2800	2300	1800	1500	1200
30000 (0.56 M)	Pitch (deg)	7	7	7	8	7	7
	V/S (ft/min)	2700	2000	1600	1200	900	600
37000 (0.56 M)	Pitch (deg)	7	7	8	8	8	-
	V/S (ft/min)	1800	1300	900	400	100	

UNRELIABLE AIRSPEED TABLES (Cruise)

Airplane: EMB-145 – Engine: AE3007A1 & A1P – Anti-Ice: OFF

PRESSURE ALTITUDE (ft)		WEIGHT (lb)					
		30000	35000	40000	45000	50000	55000
15000 (250 KIAS)	Pitch (deg)	1	1	2	2	2	3
	N1 (%)	68.7	69.9	71.1	72.4	73.8	75.3
20000 (250 KIAS)	Pitch (deg)	1	1	2	2	2	3
	N1 (%)	72.0	73.3	74.8	76.4	78.0	79.6
25000 (250 KIAS)	Pitch (deg)	1	1	2	2	2	3
	N1 (%)	76.1	77.6	79.3	80.7	81.9	83.1
30000 (0.63 M)	Pitch (deg)	1	1	2	2	2	3
	N1 (%)	78.5	80.0	81.2	82.5	84.0	85.5
37000 (0.63 M)	Pitch (deg)	2	2	2	3	3	4
	N1 (%)	79.8	81.7	83.8	86.4	89.8	92.8

UNRELIABLE AIRSPEED TABLES (Flight Idle Descent)

Airplane: EMB-145 – Engine: AE3007A1 & A1P – Anti-Ice: OFF

PRESSURE ALTITUDE (ft)		WEIGHT (lb)					
		30000	35000	40000	45000	50000	55000
0 (240 KIAS)	Pitch (deg)	-3	-2	-2	-1	-1	0
	V/S (ft/min)	-1800	-1700	-1600	-1500	-1500	-1500
10000 (240 KIAS)	Pitch (deg)	-3	-2	-2	-1	0	0
	V/S (ft/min)	-2000	-1900	-1800	-1800	-1700	-1700
20000 (240 KIAS)	Pitch (deg)	-2	-2	-1	-1	0	0
	V/S (ft/min)	-2200	-2100	-2000	-1900	-1900	-1900
30000 (240 KIAS)	Pitch (deg)	-2	-2	-1	0	0	1
	V/S (ft/min)	-2500	-2400	-2200	-2100	-2100	-2000
37000 (240 KIAS)	Pitch (deg)	-1	-1	0	0	1	1
	V/S (ft/min)	-2400	-2200	-2100	-2100	-2000	-2000

UNRELIABLE AIRSPEED TABLES (Holding)

Airplane: EMB-145 – Engine: AE3007A1 & A1P – Anti-Ice: OFF

PRESSURE ALTITUDE (ft)		WEIGHT (lb)					
		30000	35000	40000	45000	50000	55000
5000 (200 KIAS)	Pitch (deg)	3	3	4	5	5	6
	N1 (%)	54.0	55.9	57.8	59.9	62.2	64.4
10000 (200 KIAS)	Pitch (deg)	3	3	4	5	5	6
	N1 (%)	57.5	59.5	61.8	63.9	66.2	68.4

User: aherrera - Printed By myTechCare - Jul 25/22 - 13:50:24

PERFORMANCE DATA

AE3007A1P ENGINES

UNRELIABLE AIRSPEED TABLES (Terminal Area)					
Terminal Area (5000 ft) - %N1 for Level Flight					
Airplane: EMB-145 – Engine: AE3007A1 & A1P – Anti-Ice: OFF					
FLAP POSITION (V _{REF} + INCREMENT)		WEIGHT (lb)			
		30000	35000	40000	45000
0 (V _{REF45} + 30)	Pitch (deg)	7	7	7	8
	N1 (%)	48.9	52.5	55.7	58.8
9 (V _{REF45} + 15)	Pitch (deg)	7	7	7	8
	N1 (%)	51.6	55.3	58.6	61.7

UNRELIABLE AIRSPEED TABLES (Final Approach)					
Final Approach (1500 ft) - %N1 for 3° Glideslope					
Airplane: EMB-145 – Engine: AE3007A1 & A1P – Anti-Ice: OFF					
FLAP POSITION (V _{REF} + INCREMENT)		WEIGHT (lb)			
		30000	35000	40000	45000
22 (V _{REF22} + 10)	Pitch (deg)	3	3	3	3
	N1 (%)	47.7	51.1	53.9	56.6
45 (V _{REF45} + 10)	Pitch (deg)	-1	0	0	0
	N1 (%)	58.6	62.4	65.7	68.6

User: aherrera - Printed By myTechCare - Jul 25/22 - 13:50:24

PERFORMANCE DATA

AE3007A1P ENGINES

UNRELIABLE AIRSPEED TABLES (CLB Thrust Mode)

Airplane: EMB-145 – Engine: AE3007A1 & A1P – Anti-Ice: ON

PRESSURE ALTITUDE (ft)		WEIGHT (lb)					
		30000	35000	40000	45000	50000	55000
0 (240 KIAS)	Pitch (deg) V/S (ft/min)	13 4700	11 3900	10 3400	10 2900	9 2500	9 2200
10000 (240 KIAS)	Pitch (deg) V/S (ft/min)	8 3500	8 2800	7 2400	7 1900	7 1600	6 1400
20000 (0.56 M)	Pitch (deg) V/S (ft/min)	6 3000	5 2300	5 1900	5 1500	5 1200	5 900
30000 (0.56 M)	Pitch (deg) V/S (ft/min)	6 2000	6 1400	6 1100	6 700	6 400	6 200
37000 (0.56 M)	Pitch (deg) V/S (ft/min)	6 1200	6 700	7 400	7 0	-	-

UNRELIABLE AIRSPEED TABLES (Cruise)

Airplane: EMB-145 – Engine: AE3007A1 & A1P – Anti-Ice: ON

PRESSURE ALTITUDE (ft)		WEIGHT (lb)					
		30000	35000	40000	45000	50000	55000
15000 (250 KIAS)	Pitch (deg) N1 (%)	1 68.7	1 69.9	2 71.1	2 72.4	2 73.8	3 75.3
20000 (250 KIAS)	Pitch (deg) N1 (%)	1 72.0	1 73.4	2 74.8	2 76.4	2 78.0	3 79.6
25000 (250 KIAS)	Pitch (deg) N1 (%)	1 76.1	1 77.6	2 79.3	2 80.7	2 81.9	3 83.1
30000 (0.63 M)	Pitch (deg) N1 (%)	1 78.5	1 79.9	2 81.2	2 82.5	2 84.0	3 85.5
37000 (0.63 M)	Pitch (deg) N1 (%)	2 79.8	2 81.7	2 83.8	3 86.4	3 89.8	4 92.8

UNRELIABLE AIRSPEED TABLES (Flight Idle Descent)

Airplane: EMB-145 – Engine: AE3007A1 & A1P – Anti-Ice: ON

PRESSURE ALTITUDE (ft)		WEIGHT (lb)					
		30000	35000	40000	45000	50000	55000
0 (240 KIAS)	Pitch (deg) V/S (ft/min)	-1 -900	0 -900	0 -900	0 -900	1 -900	1 -1000
10000 (240 KIAS)	Pitch (deg) V/S (ft/min)	-1 -1200	0 -1200	0 -1200	0 -1200	1 -1200	1 -1200
20000 (240 KIAS)	Pitch (deg) V/S (ft/min)	-1 -1300	0 -1300	0 -1300	0 -1300	1 -1300	1 -1400
30000 (240 KIAS)	Pitch (deg) V/S (ft/min)	0 -1400	0 -1400	0 -1400	1 -1400	1 -1400	2 -1400
37000 (240 KIAS)	Pitch (deg) V/S (ft/min)	0 -1700	0 -1600	0 -1600	1 -1500	1 -1500	2 -1500

UNRELIABLE AIRSPEED TABLES (Holding)

Airplane: EMB-145 – Engine: AE3007A1 & A1P – Anti-Ice: ON

PRESSURE ALTITUDE (ft)		WEIGHT (lb)					
		30000	35000	40000	45000	50000	55000
5000 (200 KIAS)	Pitch (deg) N1 (%)	3 54.0	3 55.9	4 57.8	5 59.9	5 62.2	6 65.7
10000 (200 KIAS)	Pitch (deg) N1 (%)	3 57.5	3 59.5	4 61.8	5 65.7	5 66.2	6 69.7

QRH-145/1115
CODE 06

User: aherrera - Printed By myTechCare - Jul 25/22 - 13:50:24

PERFORMANCE DATA

AE3007A1P ENGINES

UNRELIABLE AIRSPEED TABLES (Terminal Area)

Terminal Area (5000 ft) - %N1 for Level Flight					
Airplane: EMB-145 – Engine: AE3007A1 & A1P – Anti-Ice: ON					
FLAP POSITION (V _{REF} + INCREMENT)		WEIGHT (lb)			
		30000	35000	40000	45000
0 (V _{REF45} + 30)	Pitch (deg)	7	7	7	8
	N1 (%)	48.9	52.5	55.7	61.3
9 (V _{REF45} + 15)	Pitch (deg)	7	7	7	8
	N1 (%)	52.3	55.3	58.6	64.3

UNRELIABLE AIRSPEED TABLES (Final Approach)

Final Approach (1500 ft) - %N1 for 3° Glideslope					
Airplane: EMB-145 – Engine: AE3007A1 & A1P – Anti-Ice: ON					
FLAP POSITION (V _{REF} + INCREMENT)		WEIGHT (lb)			
		30000	35000	40000	45000
22 (V _{REF22} + 10)	Pitch (deg)	3	3	3	3
	N1 (%)	48.9	52.5	55.7	61.3
45 (V _{REF45} + 10)	Pitch (deg)	-1	0	0	0
	N1 (%)	58.6	62.4	65.7	70.9

User: aherrera - Printed By myTechCare - Jul 25/22 - 13:50:24

PERFORMANCE DATA

AE3007A1P ENGINES

TAKEOFF SPEEDS (Balanced Field Length)

V1/VR/V2 SPEEDS ALT T/O-1 MODE - NORMAL V ₂ - FLAPS 9°				
PRESSURE ALTITUDE (ft)	STATIC AIR TEMPERATURE (°C)			
SL →	-40 to 46	47 to 48	49 to 50	-
1000 →	-40 to 43	44 to 45	46 to 48	-
2000 →	-40 to 39	40 to 42	43 to 45	46 to 46
3000 →	-40 to 35	36 to 38	39 to 41	42 to 44
4000 →	-40 to 31	32 to 34	35 to 38	39 to 41
5000 →	-40 to 26	27 to 30	31 to 33	34 to 37
6000 →	-	-40 to 25	26 to 29	30 to 32
7000 →	-	-40 to 20	21 to 24	25 to 28
8000 →	-	-	-40 to 20	21 to 24
10000 →	-	-	-	-40 to 23
	↓	↓	↓	↓
WEIGHT (lb)	V1 VR V2	V1 VR V2	V1 VR V2	V1 VR V2
26500	100 104 122	98 102 119	97 100 117	95 98 114
27500	100 104 121	99 102 119	97 100 116	95 98 113
28500	100 104 120	99 102 118	97 100 115	95 98 113
29500	100 104 120	99 102 117	97 100 115	97 99 114
30500	100 103 119	98 101 117	98 101 115	99 101 115
31500	100 103 119	99 101 116	100 102 116	101 103 116
32500	101 103 118	102 104 118	103 104 118	103 105 118
33500	104 106 120	104 106 120	105 107 120	106 107 120
34500	106 108 122	107 108 122	108 109 122	108 109 122
35500	108 110 123	109 110 123	110 111 123	111 111 123
36500	111 112 125	111 112 125	112 113 125	113 114 125
37500	113 114 127	114 115 127	115 115 127	115 116 127
38500	115 116 128	116 117 128	117 117 128	117 118 128
39500	118 118 130	118 119 130	119 119 130	119 120 130
40500	120 120 132	120 121 132	121 121 132	121 122 132
41500	122 122 133	122 122 133	123 123 133	123 124 133
42500	124 124 135	124 124 135	125 125 135	125 125 135
43500	126 126 136	126 126 136	127 127 136	127 127 136
44500	128 128 138	128 128 138	129 129 138	129 129 138
45500	129 129 139	130 130 139	130 130 139	131 131 139
46500	131 131 141	132 132 141	132 132 141	133 133 141
47500	133 133 142	133 133 142	134 134 142	134 134 142
48500	134 134 144	135 135 144	135 135 144	136 136 144

FINAL SEGMENT SPEED (V_{FS})

WEIGHT (lb)	V _{FS} (KIAS)	WEIGHT (lb)	V _{FS} (KIAS)	WEIGHT (lb)	V _{FS} (KIAS)
26000	132	35000	152	44000	169
27000	134	36000	154	45000	171
28000	136	37000	156	46000	172
29000	139	38000	158	47000	173
30000	141	39000	160	48000	175
31000	142	40000	162	49000	177
32000	145	41000	164	50000	179
33000	147	42000	165		
34000	150	43000	167		

User: aherrera - Printed By myTechCare - Jul 25/22 - 13:50:24

QRH-145/1115
CODE 06

REVISION 17

PD-7

Copyright © by Embraer. Refer to cover page for details.

PERFORMANCE DATA

AE3007A1P ENGINES

TAKEOFF SPEEDS (Balanced Field Length)

V1/VR/V2 SPEEDS
ALT T/O-1 MODE - NORMAL V₂ - FLAPS 9°

PRESSURE ALTITUDE (ft)	STATIC AIR TEMPERATURE (°C)					
	V1		VR		V2	
SL →	-	-	-	-	-	-
1000 →	-	-	-	-	-	-
2000 →	-	-	-	-	-	-
3000 →	-	-	-	-	-	-
4000 →	42 to 42	-	-	-	-	-
5000 →	38 to 40	-	-	-	-	-
6000 →	33 to 36	37 to 38	-	-	-	-
7000 →	29 to 32	33 to 35	36 to 36	-	-	-
8000 →	25 to 27	28 to 31	32 to 34	-	-	-
10000 →	-	22 to 25	26 to 32	-	-	-
	↓	↓	↓			
WEIGHT (lb)	V1 VR V2		V1 VR V2		V1 VR V2	
26500	94	96 112	92	94 109	91	92 107
27500	93	96 111	92	94 109	94	95 109
28500	94	96 111	95	97 111	96	98 111
29500	97	99 112	98	99 112	99	100 112
30500	99	101 114	100	102 114	101	102 114
31500	102	103 116	103	104 116	104	105 116
32500	104	106 118	105	106 118	106	107 118
33500	107	108 120	108	109 120	109	109 120
34500	109	110 122	110	111 122	111	111 122
35500	112	112 123	112	113 123	113	113 123
36500	114	114 125	115	115 125	115	115 125
37500	116	116 127	117	117 127	117	117 127
38500	118	118 128	119	119 128	119	119 128
39500	120	120 130	121	121 130	121	121 130
40500	122	122 132	123	123 132	123	123 132
41500	124	124 133	125	125 133	125	125 133
42500	126	126 135	126	126 135	127	127 135
43500	128	128 136	128	128 136	129	129 136
44500	130	130 138	130	130 138	131	131 138
45500	131	131 139	132	132 139	132	132 139
46500	133	133 141	134	134 141	134	134 141
47500	135	135 142	135	135 142	136	136 142
48500	136	136 144	137	137 144	137	137 144

User: aherrera - Printed By myTechCare - Jul 25/22 - 13:50:24

PERFORMANCE DATA

AE3007A1P ENGINES

TAKEOFF SPEEDS (Unbalanced Field Length)						
VR/V2 SPEEDS T/O-1 MODE - NORMAL V ₂ - FLAPS 9°						
PRESSURE ALTITUDE (ft)	STATIC AIR TEMPERATURE (°C)					
	SL →	-40 to 39	40 to 44	45 to 48	49 to 50	-
1000 →	-40 to 35	36 to 40	41 to 44	45 to 48	-	-
2000 →	-40 to 30	31 to 36	37 to 41	42 to 46	-	-
3000 →	-	-40 to 32	33 to 37	38 to 42	43 to 44	-
4000 →	-	-40 to 27	28 to 33	34 to 38	39 to 42	-
5000 →	-	-	-40 to 28	29 to 34	35 to 40	-
6000 →	-	-	-40 to 24	25 to 30	31 to 36	-
7000 →	-	-	-	-40 to 25	26 to 31	-
8000 →	-	-	-	-40 to 21	22 to 27	-
10000 →	-	-	-	-	-40 to 26	-
	↓	↓	↓	↓	↓	↓
WEIGHT (lb)	VR	V2	VR	V2	VR	V2
26500	109	128	106	124	103	120
27500	109	127	105	123	102	119
28500	108	126	105	122	102	118
29500	108	125	105	121	102	117
30500	107	124	104	121	101	117
31500	107	124	104	120	101	116
32500	107	123	104	119	103	118
33500	107	123	105	120	106	120
34500	106	122	107	122	108	122
35500	108	123	109	123	110	123
36500	110	125	111	125	112	125
37500	112	127	113	127	114	127
38500	114	128	115	128	116	128
39500	116	130	117	130	118	130
40500	118	132	119	132	120	132
41500	120	133	121	133	121	132
42500	122	135	123	135	123	133
43500	124	136	125	136	124	135
44500	126	138	127	138	125	135
45500	128	139	129	139	126	136
46500	130	141	130	141	127	136
47500	131	142	132	142	128	136
48500	133	144	134	144	129	138

NOTE: For determining V₁, enter the appropriate takeoff analysis with the Static Air Temperature and wind and read V₁ for the Maximum Takeoff Weight. Use the lower between this V₁ and the V_R obtained from the above table as the V₁ for the actual Takeoff Weight.

PERFORMANCE DATA

AE3007A1P ENGINES

TAKEOFF SPEEDS (Unbalanced Field Length)

VR/V2 SPEEDS T/O-1 MODE - NORMAL V₂ - FLAPS 18°

PRESSURE ALTITUDE (ft)	STATIC AIR TEMPERATURE (°C)										
	VR		V2		VR		V2		VR		V2
SL →	-40 to 41	42 to 48	49 to 50	-	-						
1000 →	-40 to 38	39 to 45	46 to 48	-	-						
2000 →	-40 to 33	34 to 41	42 to 46	-	-						
3000 →	-40 to 29	30 to 37	38 to 44	-	-						
4000 →	-	-40 to 33	34 to 41	42 to 42	-						
5000 →	-	-40 to 29	30 to 37	38 to 40	-						
6000 →	-	-40 to 24	25 to 33	34 to 38	-						
7000 →	-	-	-40 to 28	29 to 36	-						
8000 →	-	-	-40 to 24	25 to 32	33 to 34						
10000 →	-	-	-	-40 to 25	26 to 33						
	↓	↓	↓	↓	↓						
WEIGHT (lb)	VR	V2	VR	V2	VR	V2	VR	V2	VR	V2	
26500	109	123	104	118	100	112	99	110	98	108	
27500	108	122	104	117	101	113	100	111	98	109	
28500	108	122	104	116	102	114	100	112	99	109	
29500	108	121	104	117	103	115	102	113	101	110	
30500	108	120	106	118	105	116	104	114	103	111	
31500	108	121	107	119	106	117	105	115	104	112	
32500	109	121	108	119	107	117	106	116	106	114	
33500	110	122	109	120	108	118	108	116	107	115	
34500	111	123	110	121	109	119	109	117	108	116	
35500	112	124	111	122	110	120	110	118	110	117	
36500	113	124	112	122	112	121	111	119	111	118	
37500	114	125	113	123	113	121	112	120	112	119	
38500	115	126	114	124	114	122	113	121	114	120	
39500	116	126	115	125	115	123	115	122	115	122	
40500	117	127	116	125	116	124	116	123	117	123	
41500	118	128	117	126	117	125	118	125	118	124	
42500	119	128	118	127	118	126	119	126	120	126	
43500	120	129	119	128	120	127	121	127	122	127	
44500	121	130	120	128	121	128	122	128	123	128	
45500	121	130	122	130	123	130	124	130	125	130	
46500	122	131	123	131	124	131	125	131	126	131	
47500	124	132	125	132	126	132	127	132	128	132	
48500	125	133	126	133	127	133	128	133	130	134	

NOTE: For determining V₁, enter the appropriate takeoff analysis with the Static Air Temperature and wind and read V₁ for the Maximum Takeoff Weight. Use the lower between this V₁ and the V_R obtained from the above table as the V₁ for the actual Takeoff Weight.

PERFORMANCE DATA

AE3007A1P ENGINES

TAKEOFF SPEEDS (Unbalanced Field Length)				
VR/V2 SPEEDS T/O-1 MODE - NORMAL V ₂ - FLAPS 22°				
PRESSURE ALTITUDE (ft)	STATIC AIR TEMPERATURE (°C)			
SL →	-40 to 46	47 to 50	-	-
1000 →	-40 to 43	44 to 48	-	-
2000 →	-40 to 39	40 to 46	-	-
3000 →	-40 to 35	36 to 42	43 to 44	-
4000 →	-40 to 31	32 to 38	39 to 42	-
5000 →	-40 to 26	27 to 34	35 to 40	-
6000 →	-40 to 22	23 to 30	31 to 38	-
7000 →	-40 to 18	19 to 25	26 to 33	34 to 36
8000 →	-	-40 to 20	21 to 29	30 to 34
10000 →	-	-	-40 to 24	25 to 33
	↓	↓	↓	↓
WEIGHT (lb)	VR V2	VR V2	VR V2	VR V2
26500	96 107	94 104	93 102	92 101
27500	96 107	96 105	95 103	94 102
28500	98 108	97 106	96 104	95 103
29500	99 108	98 107	97 105	96 103
30500	100 109	99 108	98 106	98 104
31500	101 110	101 109	100 107	99 105
32500	103 111	102 109	101 108	101 107
33500	104 112	103 110	102 109	103 109
34500	105 113	104 111	104 110	105 110
35500	106 114	105 112	106 112	106 112
36500	107 114	106 113	107 113	108 113
37500	108 115	108 115	109 115	109 115
38500	109 116	109 116	110 116	111 116
39500	110 118	111 118	112 118	112 118
40500	112 119	112 119	113 119	114 119
41500	113 120	114 120	115 120	115 120
42500	115 121	115 121	116 121	117 121
43500	116 122	117 122	117 122	118 122
44500	117 123	118 123	119 123	119 124
45500	119 125	119 125	120 125	121 125
46500	120 126	121 126	121 126	122 126
47500	121 127	122 127	123 127	123 127
48500	122 128	123 128	124 128	124 128

NOTE: For determining V₁, enter the appropriate takeoff analysis with the Static Air Temperature and wind and read V₁ for the Maximum Takeoff Weight. Use the lower between this V₁ and the V_R obtained from the above table as the V₁ for the actual Takeoff Weight.

PERFORMANCE DATA

AE3007A1P ENGINES

**APPROACH CLIMB SPEED (V_{APPCLB}),
LANDING CLIMB &
REFERENCE SPEEDS (V_{REF}) and
FINAL SEGMENT SPEED (V_{FS})**

WEIGHT (lb)	Approach Climb Speed (KIAS)	Landing Climb & Reference Speeds (KIAS)		V_{FS} (KIAS)
	Flaps 9°	Flaps 45°	Flaps 22°	
27000	125	104	109	134
28000	128	106	111	136
29000	130	108	113	139
30000	132	109	114	141
31000	134	111	116	142
32000	136	113	118	145
33000	138	115	120	147
34000	140	117	121	150
35000	142	118	123	152
36000	144	120	125	154
37000	146	121	127	156
38000	148	123	128	158
39000	150	124	130	160
40000	152	126	131	162
41000	154	127	133	164
42000	156	128	134	165
43000	157	130	136	167
44000	159	131	137	169
45000	161	132	139	171
46000	163	134	140	172
47000	164	135	142	173
48000	166	136	143	175
49000	167	137	144	177
50000	167	137	144	179

APPROACH SPEED (V_{APP})

$$V_{APP} = V_{REF} + \frac{1}{2} \text{ headwind} + \text{full gust}$$

PERFORMANCE DATA

AE3007A1P ENGINES

HOLDING - (All Engines)

CRUISE CONFIGURATION, BLEED OPEN

ANTI-ICE: OFF

MINIMUM FUEL CONSUMPTION SPEED, STANDARD ATMOSPHERE

WEIGHT (lb)	ALTITUDE (ft)										
		0	5000	10000	15000	20000	25000	30000	35000	37000	
49000	IAS	kt	179	174	171	169	170	172	177	185	184
	N1	%	57.2	61.0	65.3	69.1	73.2	77.9	82.0	86.6	89.6
	FF	lb/h/Eng	1072	1028	997	979	974	974	984	1011	1029
48000	IAS	kt	178	173	170	168	168	170	174	182	184
	N1	%	56.7	60.4	64.7	68.6	72.6	77.4	81.5	85.8	88.9
	FF	lb/h/Eng	1054	1009	977	959	952	952	961	985	1003
46000	IAS	kt	175	170	167	165	164	166	170	177	180
	N1	%	55.6	59.3	63.5	67.7	71.4	76.2	80.3	84.5	87.4
	FF	lb/h/Eng	1018	972	939	918	909	908	914	935	952
44000	IAS	kt	173	168	164	161	161	162	165	171	175
	N1	%	54.5	58.1	62.3	66.6	70.2	74.9	79.2	83.3	85.7
	FF	lb/h/Eng	983	935	900	878	867	866	869	885	900
42000	IAS	kt	170	165	161	158	157	158	161	166	169
	N1	%	53.3	56.8	61.0	65.3	69.1	73.6	78.1	82.1	84.2
	FF	lb/h/Eng	948	898	862	838	825	823	824	837	850
40000	IAS	kt	168	162	158	155	153	154	156	161	164
	N1	%	52.2	55.6	59.6	64.0	67.9	72.2	76.9	81.1	82.9
	FF	lb/h/Eng	914	863	825	799	784	780	780	790	801
38000	IAS	kt	166	160	155	152	150	150	151	155	158
	N1	%	50.9	54.3	58.2	62.6	66.8	70.7	75.6	79.7	81.7
	FF	lb/h/Eng	880	827	788	761	744	738	737	744	753
36000	IAS	kt	163	157	152	148	146	145	147	150	152
	N1	%	49.7	53.0	56.8	61.1	65.5	69.3	74.1	78.3	80.5
	FF	lb/h/Eng	847	793	752	723	705	696	695	699	707
34000	IAS	kt	161	154	149	145	142	141	142	145	147
	N1	%	48.5	51.6	55.4	59.6	64.0	67.9	72.5	76.9	79.0
	FF	lb/h/Eng	814	759	716	686	666	655	654	655	661
32000	IAS	kt	158	152	146	142	139	137	138	140	141
	N1	%	47.2	50.2	53.8	57.9	62.4	66.4	70.8	75.5	77.4
	FF	lb/h/Eng	782	725	682	650	628	615	611	612	616
30000	IAS	kt	156	149	143	139	135	133	133	135	136
	N1	%	45.9	48.7	52.3	56.2	60.7	65.0	69.0	73.9	75.9
	FF	lb/h/Eng	751	693	647	614	590	576	570	569	573
28000	IAS	kt	154	146	140	135	132	129	128	129	130
	N1	%	44.6	47.3	50.6	54.5	58.8	63.3	67.3	72.1	74.2
	FF	lb/h/Eng	721	661	614	579	554	537	529	528	530
26000	IAS	kt	151	144	137	132	128	125	124	124	125
	N1	%	43.2	45.7	48.9	52.7	56.8	61.4	65.5	70.0	72.4
	FF	lb/h/Eng	692	630	581	544	518	500	490	487	489

User: aherrera - Printed By myTechCare - Jul 25/22 - 13:50:24

PERFORMANCE DATA

AE3007A1P ENGINES

HOLDING - (All Engines)

CRUISE CONFIGURATION, BLEED OPEN
 AIRSPEED: 1.3 V_s OR 200 KIAS WHICHEVER IS HIGHER
 ANTI-ICE: ON (NO ICE ACCRETION)
 STANDARD ATMOSPHERE

WEIGHT (lb)			ALTITUDE (ft)									
			0	5000	10000	15000	20000	25000	30000	35000	37000	
49000	IAS	kt	200	200	200	200	200	200	200	200	200	200
	N1	%	58.4	62.2	66.4	69.9	74.0	78.8	83.0	88.1	91.4	
	FF	lb/h/Eng	1227	1171	1128	1099	1087	1083	1092	1120	1141	
48000	IAS	kt	200	200	200	200	200	200	200	200	200	200
	N1	%	57.9	61.7	65.9	69.5	73.5	78.4	82.5	87.2	90.8	
	FF	lb/h/Eng	1212	1155	1112	1082	1069	1065	1072	1098	1117	
46000	IAS	kt	200	200	200	200	200	200	200	200	200	200
	N1	%	57.1	60.8	65.0	68.8	72.6	77.4	81.5	85.7	89.3	
	FF	lb/h/Eng	1183	1126	1081	1050	1034	1030	1033	1055	1073	
44000	IAS	kt	200	200	200	200	200	200	200	200	200	200
	N1	%	56.3	59.9	64.1	68.1	71.6	76.5	80.6	84.7	87.6	
	FF	lb/h/Eng	1155	1097	1051	1019	1000	996	997	1014	1030	
42000	IAS	kt	200	200	200	200	200	200	200	200	200	200
	N1	%	55.5	59.1	63.3	67.3	70.8	75.4	79.7	83.8	85.9	
	FF	lb/h/Eng	1129	1070	1023	989	968	963	962	975	989	
40000	IAS	kt	200	200	200	200	200	200	200	200	200	200
	N1	%	54.6	58.3	62.4	66.5	69.9	74.4	78.9	82.9	84.8	
	FF	lb/h/Eng	1103	1043	996	960	937	930	929	939	951	
38000	IAS	kt	200	200	200	200	200	200	200	200	200	200
	N1	%	53.8	57.4	61.5	65.6	69.1	73.3	78.2	82.1	84.0	
	FF	lb/h/Eng	1079	1018	970	933	908	899	899	905	916	
36000	IAS	kt	200	200	200	200	200	200	200	200	200	200
	N1	%	53.1	56.6	60.6	64.8	68.4	72.4	77.3	81.1	83.1	
	FF	lb/h/Eng	1055	995	945	907	881	869	870	874	882	
34000	IAS	kt	200	200	200	200	200	200	200	200	200	200
	N1	%	52.3	55.8	59.7	63.9	67.7	71.4	76.4	80.2	82.3	
	FF	lb/h/Eng	1033	972	922	883	855	841	842	844	851	
32000	IAS	kt	200	200	200	200	200	200	200	200	200	200
	N1	%	51.6	55.0	58.9	63.1	67.0	70.6	75.3	79.4	81.4	
	FF	lb/h/Eng	1012	951	900	859	830	814	813	817	823	
30000	IAS	kt	200	200	200	200	200	200	200	200	200	200
	N1	%	50.9	54.3	58.1	62.3	66.3	69.7	74.3	78.7	80.5	
	FF	lb/h/Eng	993	930	879	838	807	789	785	791	796	
28000	IAS	kt	200	200	200	200	200	200	200	200	200	200
	N1	%	50.2	53.6	57.4	61.5	65.5	68.9	73.3	78.0	79.8	
	FF	lb/h/Eng	974	911	859	817	785	765	759	768	772	
26000	IAS	kt	200	200	200	200	200	200	200	200	200	200
	N1	%	49.5	52.8	56.6	60.7	64.8	68.2	72.3	77.3	79.1	
	FF	lb/h/Eng	957	894	841	798	765	743	735	742	750	

User: aherrera - Printed By MyTechCare - Jul 25/22 - 13:50:24

PERFORMANCE DATA

AE3007A1P ENGINES

HOLDING - (All Engines)

CRUISE CONFIGURATION, BLEED OPEN
 AIRSPEED: 1.3 V_S OR 200 KIAS WHICHEVER IS HIGHER
 ANTI-ICE ON (WITH ICE ACCRETION)
 STANDARD ATMOSPHERE

WEIGHT (lb)			ALTITUDE (ft)									
			0	5000	10000	15000	20000	25000	30000	35000	37000	
49000	IAS	kt	200	200	200	200	200	200	200	200	200	200
	N1	%	58.4	62.2	66.4	69.9	74.0	78.8	83.0	88.1	91.4	
	FF	lb/h/Eng	1358	1286	1227	1184	1159	1145	1148	1174	1195	
48000	IAS	kt	200	200	200	200	200	200	200	200	200	200
	N1	%	57.9	61.7	65.9	69.5	73.5	78.4	82.5	87.2	90.8	
	FF	lb/h/Eng	1344	1271	1212	1168	1141	1127	1127	1150	1170	
46000	IAS	kt	200	200	200	200	200	200	200	200	200	200
	N1	%	57.1	60.8	65.0	68.8	72.6	77.4	81.5	85.7	89.3	
	FF	lb/h/Eng	1316	1241	1181	1135	1106	1092	1088	1106	1123	
44000	IAS	kt	200	200	200	200	200	200	200	200	200	200
	N1	%	56.3	59.9	64.1	68.1	71.6	76.5	80.6	84.7	87.6	
	FF	lb/h/Eng	1288	1213	1152	1104	1073	1058	1050	1063	1078	
42000	IAS	kt	200	200	200	200	200	200	200	200	200	200
	N1	%	55.5	59.1	63.3	67.3	70.8	75.4	79.7	83.8	85.9	
	FF	lb/h/Eng	1262	1186	1123	1074	1040	1025	1015	1023	1036	
40000	IAS	kt	200	200	200	200	200	200	200	200	200	200
	N1	%	54.6	58.3	62.4	66.5	69.9	74.4	78.9	82.9	84.8	
	FF	lb/h/Eng	1236	1160	1097	1046	1010	991	982	986	996	
38000	IAS	kt	200	200	200	200	200	200	200	200	200	200
	N1	%	53.8	57.4	61.5	65.6	69.1	73.3	78.2	82.1	84.0	
	FF	lb/h/Eng	1212	1135	1071	1019	981	960	951	951	960	
36000	IAS	kt	200	200	200	200	200	200	200	200	200	200
	N1	%	53.1	56.6	60.6	64.8	68.4	72.4	77.3	81.1	83.1	
	FF	lb/h/Eng	1189	1112	1047	994	954	930	922	918	925	
34000	IAS	kt	200	200	200	200	200	200	200	200	200	200
	N1	%	52.3	55.8	59.7	63.9	67.7	71.4	76.4	80.2	82.3	
	FF	lb/h/Eng	1168	1090	1024	970	928	902	893	888	893	
32000	IAS	kt	200	200	200	200	200	200	200	200	200	200
	N1	%	51.6	55.0	58.9	63.1	67.0	70.6	75.3	79.4	81.4	
	FF	lb/h/Eng	1147	1068	1002	947	904	875	864	860	864	
30000	IAS	kt	200	200	200	200	200	200	200	200	200	200
	N1	%	50.9	54.3	58.1	62.3	66.3	69.7	74.3	78.7	80.5	
	FF	lb/h/Eng	1128	1049	981	925	881	850	836	834	836	
28000	IAS	kt	200	200	200	200	200	200	200	200	200	200
	N1	%	50.2	53.6	57.4	61.5	65.5	68.9	73.3	78.0	79.8	
	FF	lb/h/Eng	1109	1030	962	905	860	827	809	810	811	
26000	IAS	kt	200	200	200	200	200	200	200	200	200	200
	N1	%	49.5	52.8	56.6	60.7	64.8	68.2	72.3	77.3	79.1	
	FF	lb/h/Eng	1092	1012	944	886	840	805	785	784	789	

User: aherrera - Printed By myTechCare - Jul 25/22 - 13:50:24

PERFORMANCE DATA

AE3007A1P ENGINES

DRIFTDOWN TABLE ANTI-ICE OFF

WEIGHT (lb)		INITIAL DRIFTDOWN SPEED (KIAS)	GROSS LEVEL OFF ALTITUDE – FT (NET LEVEL OFF ALTITUDE - FT)		
START DRIFTDOWN	LEVEL OFF		ISA + 10 & BELOW	ISA + 15	ISA + 20
50000	48000	179	17900 (13800)	17700 (13700)	17400 (12900)
48000	46100	176	19100 (14400)	19000 (14300)	18800 (14000)
46000	44200	172	20770 (16010)	20640 (15930)	20220 (15690)
44000	42300	169	22030 (17490)	21880 (17390)	21470 (17180)
42000	40500	165	23430 (19400)	23050 (19250)	22710 (18760)
40000	38700	161	24860 (21055)	24520 (20910)	23950 (20410)
38000	36900	157	26440 (22460)	26170 (22260)	25470 (21950)
36000	34900	154	28150 (24110)	27520 (23730)	26920 (23250)
34000	33000	149	29820 (25850)	29220 (25560)	28260 (24890)
32000	31100	145	31870 (27550)	30784 (27000)	29680 (26410)

User: aherrera - Printed By myTechCare - Jul 25/22 - 13:50:24

PERFORMANCE DATA

AE3007A1P ENGINES

DRIFTDOWN TABLE							
ANTI-ICE ON							
WEIGHT (lb)		INITIAL SPEED (KIAS)	GROSS AND (NET) LEVEL OFF ALTITUDE - FT				
START DRIFTDOWN	LEVEL OFF		ISA - 10 & BELOW	ISA - 5	ISA	ISA + 5	ISA + 10
50000	47400	179	14100 (10000)	13900 (9900)	13100 (9400)	11500 (6800)	9900 (6000)
48000	45700	176	15700 (11500)	15500 (11400)	14500 (10900)	12800 (8800)	11300 (7500)
46000	43600	173	17190 (13220)	17090 (13030)	15980 (12280)	14260 (10670)	12630 (8550)
44000	42000	169	18730 (14620)	18540 (14410)	17480 (13460)	15620 (11890)	13850 (10330)
42000	40100	165	20390 (16150)	20200 (15940)	19200 (14940)	17370 (13260)	15350 (11750)
40000	38200	161	21790 (17840)	21450 (17780)	20600 (16620)	18920 (14830)	16960 (13220)
38000	36300	158	23180 (19780)	22730 (19570)	21840 (18350)	20540 (16590)	18450 (14670)
36000	34400	154	24590 (21390)	24300 (21050)	23150 (20270)	21850 (18450)	20010 (16400)
34000	32600	149	26080 (22990)	25340 (22580)	24420 (21670)	23190 (20370)	21410 (18250)
32000	30700	145	27370 (24460)	26550 (23900)	25660 (23020)	24390 (21700)	22690 (19810)

User: aherrera - Printed By myTechCare - Jul 25/22 - 13:50:24

PERFORMANCE DATA

AE3007A1P ENGINES

UNFACTORED LANDING DISTANCE

UNFACTORED LANDING DISTANCE (FT) – DRY RUNWAY
 EMB-145 - FLAPS 45°
 ISA CONDITIONS - SLOPE 0%

WEIGHT (lb)	ALTITUDE							
	0 ft				1000 ft			
	WIND				WIND			
	-10 kt	0 kt	10 kt	20 kt	-10 kt	0 kt	10 kt	20 kt
44000	3298	2830	2683	2540	3371	2896	2747	2603
42000	3190	2732	2588	2449	3260	2795	2650	2509
40000	3085	2637	2497	2360	3149	2695	2552	2415
38000	2984	2546	2408	2275	3046	2601	2462	2326
36000	2883	2454	2320	2189	2942	2507	2371	2239
34000	2778	2359	2227	2100	2834	2410	2277	2147
32000	2668	2259	2131	2006	2721	2307	2178	2051
30000	2555	2157	2032	1911	2605	2202	2076	1953
28000	2441	2054	1932	1813	2488	2097	1974	1854

WEIGHT (lb)	ALTITUDE							
	2000 ft				3000 ft			
	WIND				WIND			
	-10 kt	0 kt	10 kt	20 kt	-10 kt	0 kt	10 kt	20 kt
44000	3448	2965	2814	2668	3527	3037	2884	2735
42000	3333	2861	2714	2570	3409	2930	2780	2635
40000	3218	2758	2614	2473	3291	2823	2677	2534
38000	3110	2659	2518	2381	3176	2720	2576	2437
36000	3002	2562	2424	2290	3065	2620	2479	2344
34000	2892	2462	2327	2196	2952	2516	2380	2247
32000	2776	2358	2226	2098	2834	2409	2276	2147
30000	2657	2250	2122	1998	2712	2299	2169	2043
28000	2537	2141	2017	1896	2588	2188	2062	1939

WEIGHT (lb)	ALTITUDE							
	4000 ft				5000 ft			
	WIND				WIND			
	-10 kt	0 kt	10 kt	20 kt	-10 kt	0 kt	10 kt	20 kt
44000	3611	3113	2957	2806	3696	3191	3032	2879
42000	3488	3002	2849	2702	3570	3076	2921	2771
40000	3367	2891	2743	2599	3445	2962	2812	2665
38000	3247	2783	2638	2497	3319	2849	2701	2558
36000	3132	2679	2537	2400	3200	2741	2597	2458
34000	3015	2573	2436	2301	3080	2633	2493	2356
32000	2894	2464	2329	2197	2956	2519	2383	2250
30000	2768	2350	2220	2092	2827	2404	2271	2142
28000	2642	2236	2109	1984	2698	2286	2157	2032

NOTE: Landing distance in feet.

User: aherrera - Printed By myTechCare - Jul 25/22 - 13:50:24

PERFORMANCE DATA

AE3007A1P ENGINES

UNFACTORED LANDING DISTANCE

UNFACTORED LANDING DISTANCE (FT) – DRY RUNWAY
 EMB-145 - FLAPS 45°
 ISA CONDITIONS - SLOPE 0%

WEIGHT (lb)	ALTITUDE							
	6000 ft				7000 ft			
	WIND				WIND			
	-10 kt	0 kt	10 kt	20 kt	-10 kt	0 kt	10 kt	20 kt
44000	3778	3270	3111	2956	3871	3355	3192	3035
42000	3648	3152	2996	2846	3736	3233	3074	2921
40000	3518	3035	2883	2735	3602	3111	2957	2807
38000	3389	2917	2769	2625	3469	2990	2839	2693
36000	3265	2805	2660	2520	3338	2872	2725	2583
34000	3141	2693	2552	2415	3210	2756	2613	2474
32000	3013	2577	2439	2306	3079	2637	2497	2362
30000	2882	2458	2324	2195	2944	2515	2379	2248
28000	2750	2338	2208	2083	2809	2392	2260	2133

WEIGHT (lb)	ALTITUDE							
	8000 ft				9000 ft			
	WIND				WIND			
	-10 kt	0 kt	10 kt	20 kt	-10 kt	0 kt	10 kt	20 kt
44000	3967	3442	3277	3117	4068	3534	3366	3203
42000	3828	3316	3155	2999	3924	3403	3239	3080
40000	3689	3190	3033	2881	3780	3273	3113	2958
38000	3551	3065	2912	2764	3638	3143	2988	2837
36000	3415	2941	2792	2648	3496	3015	2863	2716
34000	3282	2821	2675	2535	3357	2889	2741	2599
32000	3147	2699	2557	2420	3218	2763	2619	2480
30000	3009	2573	2436	2303	3076	2634	2495	2360
28000	2869	2447	2314	2185	2933	2504	2369	2238

WEIGHT (lb)	ALTITUDE			
	10000 ft			
	WIND			
	-10 kt	0 kt	10 kt	20 kt
44000	4171	3627	3456	3290
42000	4022	3491	3325	3163
40000	3873	3357	3195	3037
38000	3726	3223	3065	2912
36000	3579	3090	2936	2787
34000	3434	2959	2809	2664
32000	3290	2828	2682	2541
30000	3144	2696	2554	2418
28000	2997	2562	2425	2293

NOTE: Landing distance in feet.

User: aherrera - Printed By myTechCare - Jul 25/22 - 13:50:24

PERFORMANCE DATA

AE3007A1P ENGINES

UNFACTORED LANDING DISTANCE

UNFACTORED LANDING DISTANCE (FT) – DRY RUNWAY

EMB-145 - FLAPS 22°

ISA CONDITIONS - SLOPE 0%

WEIGHT (lb)	ALTITUDE							
	0 ft				1000 ft			
	WIND				WIND			
	-10 kt	0 kt	10 kt	20 kt	-10 kt	0 kt	10 kt	20 kt
44000	4281	3709	3529	3353	4381	3800	3617	3438
42000	4123	3566	3390	3218	4218	3652	3473	3298
40000	3964	3421	3249	3081	4053	3502	3327	3158
38000	3810	3281	3114	2951	3895	3358	3188	3022
36000	3660	3145	2982	2823	3740	3217	3052	2890
34000	3507	3005	2846	2692	3581	3073	2912	2755
32000	3356	2869	2714	2563	3427	2932	2776	2623
30000	3212	2737	2587	2440	3278	2798	2645	2497
28000	3067	2606	2459	2317	3129	2662	2514	2369

WEIGHT (lb)	ALTITUDE							
	2000 ft				3000 ft			
	WIND				WIND			
	-10 kt	0 kt	10 kt	20 kt	-10 kt	0 kt	10 kt	20 kt
44000	4485	3895	3708	3527	4594	3994	3804	3620
42000	4316	3741	3559	3382	4419	3835	3650	3470
40000	4145	3586	3409	3236	4242	3674	3494	3319
38000	3982	3437	3265	3097	4073	3520	3346	3175
36000	3822	3292	3124	2961	3908	3370	3200	3034
34000	3659	3143	2980	2821	3740	3217	3052	2891
32000	3499	2998	2840	2685	3576	3068	2907	2750
30000	3346	2859	2705	2555	3418	2925	2768	2616
28000	3193	2720	2570	2424	3260	2781	2629	2481

WEIGHT (lb)	ALTITUDE							
	4000 ft				5000 ft			
	WIND				WIND			
	-10 kt	0 kt	10 kt	20 kt	-10 kt	0 kt	10 kt	20 kt
44000	4707	4097	3904	3716	4827	4205	4009	3818
42000	4526	3932	3744	3562	4639	4034	3844	3658
40000	4343	3766	3583	3406	4450	3863	3677	3496
38000	4169	3607	3429	3256	4269	3698	3518	3342
36000	3998	3452	3279	3111	4092	3538	3362	3191
34000	3824	3294	3126	2962	3913	3374	3204	3038
32000	3655	3140	2976	2818	3738	3215	3050	2889
30000	3492	2992	2834	2679	3570	3063	2902	2746
28000	3330	2844	2690	2540	3402	2910	2754	2602

NOTE: Landing distance in feet.

PERFORMANCE DATA

AE3007A1P ENGINES

UNFACTORED LANDING DISTANCE

UNFACTORED LANDING DISTANCE (FT) – DRY RUNWAY
 EMB-145 - FLAPS 22°
 ISA CONDITIONS - SLOPE 0%

WEIGHT (lb)	ALTITUDE							
	6000 ft				7000 ft			
	WIND				WIND			
	-10 kt	0 kt	10 kt	20 kt	-10 kt	0 kt	10 kt	20 kt
44000	4952	4319	4119	3925	5081	4436	4233	4035
42000	4756	4141	3947	3758	4878	4252	4055	3862
40000	4560	3963	3774	3591	4675	4067	3875	3689
38000	4373	3793	3609	3431	4481	3891	3704	3523
36000	4190	3627	3449	3275	4292	3719	3538	3362
34000	4005	3458	3285	3117	4100	3545	3369	3198
32000	3824	3294	3126	2962	3913	3375	3205	3039
30000	3651	3137	2974	2815	3735	3213	3047	2886
28000	3478	2979	2821	2667	3557	3051	2890	2734

WEIGHT (lb)	ALTITUDE							
	8000 ft				9000 ft			
	WIND				WIND			
	-10 kt	0 kt	10 kt	20 kt	-10 kt	0 kt	10 kt	20 kt
44000	5216	4559	4352	4150	5357	4688	4476	4271
42000	5005	4368	4166	3971	5138	4488	4283	4084
40000	4794	4176	3981	3791	4919	4289	4091	3897
38000	4593	3993	3803	3619	4710	4099	3907	3719
36000	4398	3815	3631	3452	4508	3915	3728	3546
34000	4199	3635	3456	3283	4302	3729	3547	3371
32000	4006	3459	3286	3118	4103	3547	3371	3200
30000	3822	3292	3124	2961	3912	3374	3204	3038
28000	3638	3124	2962	2803	3722	3201	3036	2875

WEIGHT (lb)	ALTITUDE			
	10000 ft			
	WIND			
	-10 kt	0 kt	10 kt	20 kt
44000	5504	4821	4606	4397
42000	5277	4614	4406	4202
40000	5049	4408	4205	4008
38000	4832	4210	4014	3823
36000	4622	4019	3829	3644
34000	4409	3826	3641	3462
32000	4203	3638	3459	3286
30000	4006	3459	3286	3118
28000	3810	3281	3113	2950

NOTE: Landing distance in feet.

User: aherrera - Printed By myTechCare - Jul 25/22 - 13:50:24

PERFORMANCE DATA

AE3007A1P ENGINES

ADVISORY INFORMATION

EMB-145 UNFACTORED LANDING DISTANCES -
CONTAMINATED RUNWAYS (ft)

ALL ENGINES TYPES – FAA CERTIFICATION

STANDING WATER 0.125 in/SLUSH 0.15 in

WET SNOW 0.25 in/DRY SNOW 0.625 in

WEIGHT (lb)	FLAP 22°	FLAP 45°
29000	6033	4822
30000	6194	4946
31000	6357	5071
32000	6532	5201
33000	6707	5330
34000	6883	5459
35000	7058	5589
36000	7245	5721
37000	7436	5852
38000	7627	5983
39000	7819	6114
40000	8010	6246
41000	8197	6377
42000	8383	6508
43000	8570	6639
44000	8757	6768
45000	8971	6914
46000	9188	7062
47000	9404	7210
48000	9621	7357

CORRECTIONS

ALTITUDE: LANDING DISTANCE + 3% per 1000 ft
above sea level.

WIND: LANDING DISTANCE + 11% per 5 kt
tailwind.

OVERSPEED: LANDING DISTANCE + 9% per 5 kt above
 V_{REF} .

PERFORMANCE DATA

AE3007A1P ENGINES

ADVISORY INFORMATION
EMB-145 UNFACTORED LANDING DISTANCES - CONTAMINATED RUNWAYS (ft)
ALL ENGINES TYPES – FAA CERTIFICATION
STANDING WATER 0.25 in/SLUSH 0.29 in
WET SNOW 0.50 in/DRY SNOW 1.25 in

WEIGHT (lb)	FLAP 22°	FLAP 45°
29000	5276	4357
30000	5411	4464
31000	5546	4571
32000	5693	4683
33000	5839	4794
34000	5986	4905
35000	6132	5016
36000	6289	5129
37000	6448	5243
38000	6608	5356
39000	6768	5470
40000	6928	5583
41000	7086	5697
42000	7243	5810
43000	7401	5923
44000	7559	6036
45000	7739	6163
46000	7922	6292
47000	8105	6421
48000	8288	6549

CORRECTIONS	
ALTITUDE:	LANDING DISTANCE + 3% per 1000 ft above sea level.
WIND:	LANDING DISTANCE + 11% per 5 kt tailwind.
OVERSPEED:	LANDING DISTANCE + 8% per 5 kt above V_{REF} .

User: aherrera - Printed By myTechCare - Jul 25/22 - 13:50:24

PERFORMANCE DATA

AE3007A1P ENGINES

ADVISORY INFORMATION

EMB-145 UNFACTORED LANDING DISTANCES -
CONTAMINATED RUNWAYS (ft)

ALL ENGINES TYPES – FAA CERTIFICATION

STANDING WATER 0.50 in/SLUSH 0.59 in

WET SNOW 1.00 in/DRY SNOW 2.50 in

WEIGHT (lb)	FLAP 22°	FLAP 45°
29000	4411	3856
30000	4515	3943
31000	4619	4031
32000	4732	4122
33000	4845	4213
34000	4957	4304
35000	5070	4395
36000	5190	4488
37000	5313	4581
38000	5436	4674
39000	5559	4766
40000	5682	4859
41000	5804	4952
42000	5926	5044
43000	6048	5137
44000	6170	5229
45000	6310	5332
46000	6451	5437
47000	6593	5542
48000	6734	5647

CORRECTIONS

ALTITUDE: LANDING DISTANCE + 3% per 1000 ft
above sea level.

WIND: LANDING DISTANCE + 10% per 5 kt
tailwind.

OVERSPEED: LANDING DISTANCE + 8% per 5 kt above
 V_{REF} .

PERFORMANCE DATA

AE3007A1P ENGINES

ADVISORY INFORMATION
EMB-145 UNFACTORED LANDING DISTANCES -
CONTAMINATED RUNWAYS (ft)
ALL ENGINES TYPES – FAA CERTIFICATION
COMPACTED SNOW

WEIGHT (lb)	FLAP 22°	FLAP 45°
29000	3944	3645
30000	4036	3734
31000	4129	3823
32000	4222	3909
33000	4315	3996
34000	4408	4082
35000	4501	4169
36000	4593	4250
37000	4685	4329
38000	4777	4409
39000	4868	4488
40000	4960	4567
41000	5052	4646
42000	5143	4726
43000	5235	4805
44000	5327	4884
45000	5417	4960
46000	5507	5035
47000	5597	5111
48000	5688	5186

CORRECTIONS	
ALTITUDE:	LANDING DISTANCE + 3% per 1000 ft above sea level.
WIND:	LANDING DISTANCE + 11% per 5 kt tailwind.
OVERSPEED:	LANDING DISTANCE + 7% per 5 kt above V_{REF} .

User: aherrera - Printed By myTechCare - Jul 25/22 - 13:50:24

PERFORMANCE DATA

AE3007A1P ENGINES

ADVISORY INFORMATION
EMB-145 UNFACTORED LANDING DISTANCES - CONTAMINATED RUNWAYS (ft)
ALL ENGINES TYPES – FAA CERTIFICATION
ICE

WEIGHT (lb)	FLAP 22°	FLAP 45°
29000	11551	9411
30000	11556	9406
31000	11572	9412
32000	11656	9487
33000	11740	9561
34000	11824	9635
35000	11909	9709
36000	12032	9810
37000	12170	9921
38000	12308	10032
39000	12446	10143
40000	12584	10254
41000	12721	10365
42000	12859	10476
43000	12997	10587
44000	13135	10698
45000	13303	10826
46000	13473	10955
47000	13644	11084
48000	13814	11213

CORRECTIONS	
ALTITUDE:	LANDING DISTANCE + 3% per 1000 ft above sea level.
WIND:	LANDING DISTANCE + 24% per 5 kt tailwind.
OVERSPEED:	LANDING DISTANCE + 5% per 5 kt above V_{REF} .

User: aherrera - Printed By myTechCare - Jul 25/22 - 13:50:24

INTENTIONALLY BLANK

User: aherrera - Printed By myTechCare - Jul 25/22 - 13:50:24

QRH-145/1115

EMERGENCY/ABNORMAL PROCEDURES

Appendix

EMERGENCY EVACUATION

- Parking Brake APPLY
- Cabin DEPRESSURIZE
- Fire Extinguishing Handles PULL
- APU Fuel Shutoff Button PUSH IN
- Engines and APU Fire Extinguishing
Bottles (if necessary) DISCHARGE
- Ventral Tank Transfer Knob
(if applicable) OFF
- Fuel Pumps Pwr 1 and 2 OFF
- Hydraulic Elec Pumps 1 and 2 OFF
- Cabin Crew NOTIFY
- Emerg Lts ON
- EMERGENCY EVACUATION**
Procedure ACCOMPLISH
- ATC NOTIFY
- Before leaving the airplane:
Batteries 1 and 2 OFF

END

User: aherrera - Printed By myTechCare - Jul 25/22 - 13:50:24